

ELFOEnergy Magnum - Multifunction

Air-cooled heat pump with simultaneous production hot / cold for outdoor installation

WSAN-XIN MF 18.2 - 45.2 RANGE

Nominal heating capacity **(A7/W45)** from 57 kW to 142 kW

Nominal cooling capacity **(A35/W7)** from 49 kW to 120 kW



- ▶ **SCROLL INVERTER R-410A TECHNOLOGY**
- ▶ **TWO INDEPENDENT REFRIGERATION CIRCUITS**
- ▶ **EUROVENT CLASS A IN HEATING**
- ▶ **ECOBREEZE FANS**
Silent operation and reduced fan consumptions
- ▶ **AXITOP FAN (OPTIONAL)**
For a further increase in efficiency
- ▶ **VARYFLOW+ (OPTIONAL)**
Variable water flow-rate with inverter pumps



DC Inverter

Clivet hydronic system

With over 25 years of constant technological progress, Clivet's liquid chillers and heat pumps represent state-of-the-art climate control in Residential and Commercial settings and Industrial applications.

HYDRONIC System - Air Source

	Small and Medium Commercial			Large Commercial and Industry		
	ELFOEnergy Extended Inverter ELFOEnergy Duct Inverter/Horus ELFOEnergy Vulcan	ELFOEnergy Medium / Large ² ELFOEnergy Vulcan Medium ELFOEnergy Duct Medium	ELFOEnergy Magnum	SPINchiller ³ / SPINchiller ² Duct Multi Scroll Technology		SCREWLine ³
Capacity (kW/RT)	5 ÷ 50 kW	25 ÷ 220 kW	50 ÷ 375 kW	120 ÷ 680 kW	690 ÷ 1350 kW	460 ÷ 1530 kW
ErP compliance (Heat pumps only)						
Products						
Chillers	WSAT-XIN <small>DC Inverter</small>	WSAT-XEE	WSAN-XIN <small>DC Inverter</small>	WSAT-XSC3	WSAT-XSC3	WDAT-SL3
High Temperature Chillers External Air			WSAT-XEM			WDAT-HL3 <small>DC Inverter</small>
Chillers Systems in two sections				REMOSEX	REMOSEX	
Free Cooling Chillers		WSAT-XEE (FC)	WSAT-XEM FC	WSAT-XSC3 FC	WSAT-XSC3 FC	WDAT-SL3 FC
Heat pumps	WSAN-XIN <small>DC Inverter</small>	WSAN-XEE	WSAN-XIN <small>DC Inverter</small>	WSAN-XSC3	WSAN-XSC3	
High temperature water Heat pumps	WBAN HORLIS+	WBAN	WSAN-XEM HW			
Multi-function Heat pumps			WSAN-XIN MF <small>DC Inverter</small>	WSAN-XSC3 MF		
Ducted units	WSA-XIN <small>DC Inverter</small>	WSA-XEE <small>DC Inverter</small>	WSN-XEE <small>DC Inverter</small>	WSA-XC2 <small>Chiller</small>		

Specialization

Every intended use has specific requirements which determine the overall efficiency. For this, the Clivet hydronic system always offers the best solution in every project.

- Modular range with over 8000 kW of overall capacity
- Capacity control with Screw and modular Scroll technology
- Multifunction versions
- Outdoor or indoor (ductable type) installation

Centrality of the Air Renewal

From the Air Renewal depends the comfort in the spaces. Since it often represents the main building energetic load, it also determines the running costs of the entire system.



ZEPHIR3

Packaged Primary Air supply system with thermodynamic energy recovery

- Simplifies the system, reduces the heating and cooling generators
- Purifies the air with the standard electronic filters
- Increases the energy efficiency and it also allows a savings of 40% on the running costs
- From -40°C to +50°C of outdoor air temperature

Terminal and AHU complete system

The hydronic terminal units are very diffused for their versatility and reliability. The Clivet range includes many versions that simplify the application in the different type of installation and building.



ELFOspace

High energy efficiency hydronic terminal units

AQX

Air-conditioning unit

- Cased and uncased terminal units, from 1 to 90 kW
- Horizontal and vertical installation
- Energy-saving DC fans
- Modular air conditioning units up to 160.000 m3/h
- EUROVENT certification

ELFOEnergy Magnum, three solutions to satisfy different installation requirements

MAGNUM MULTIFUNCTION WSAN-XIN MF:

- Reversible-cycle heat pump
- Chilled and hot water produced at the same time



MAGNUM HEAT PUMP WSAN-XIN:

- Reversible-cycle heat pump



MAGNUM COOL ONLY WSAT-XIN:

- Water chiller
- Hot water production with energy recovery option



Many applications require heating and cooling simultaneous production

Simultaneous opposite loads is a very frequent situation in many applications.

Large size buildings, aspect, variable insulation and different purpose ambient make recurring the request of heating and cooling simultaneously.

Many different technical solutions could be used at this purpose. Clivet believes since ever that solution differentiation is the key for success and consequently present diversified solutions for answering to only apparently similar demands.



Traditional way

The solution very common in the past is the independent production of heating and cooling thermal energy and transferring them to different ambient.

Thermal energy production thanks to one or many boilers and cooling power production with chillers is one possible solution.

Low efficiency of such kind system is well known, indeed during the periods where cooling and heating are simultaneously required, cooling energy production rejects a large quantity of thermal energy to a source and this is the working principle of a standard chiller, energy that could be used instead, supporting for example other thermal energy sources or as total replacement.



Enhanced hydronic system

Clivet, since ever pioneer of innovative solutions proposes Enhanced hydronic system as optimal solution for 90% of applications where simultaneous opposite loads are present.

Building blocks are:

- Magnum or SPINChiller heat pump;
- Primary Energy decentralized system Zephir;
- ELFOspace fancoils



Thanks to a proper primary air design and using Clivet products around 30% annual energy saving is achievable and with a more competitive capital investment*.

MULTIFUNCTION Option

Hydronic multifunction units, able to produce hot water and chilled water simultaneously and independently is the optimal solution for some industrial applications or where the four pipe air conditioning system is required.

Heat pump product family called MULTIFUNCTION (MF) is the Clivet answer.

*Dedicated documented.

MULTIFUNCTION by CLIVET

ELFOEnergy MAGNUM and SPINChiller³ MF are the two air source heat pump families for simultaneous production of hot and chilled water.

Configuration available:

- **2T:** supply water for two pipe systems;
produce chilled water or hot water to the system;
supply hot water using the total recovery device for domestic hot water tanks, pre or post heating simultaneously with chilled water production;

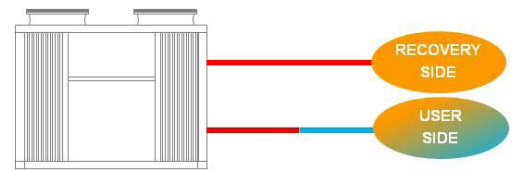

- **4T:** supply water for four pipe systems;
produce chilled water and hot water to the system simultaneously and independently.

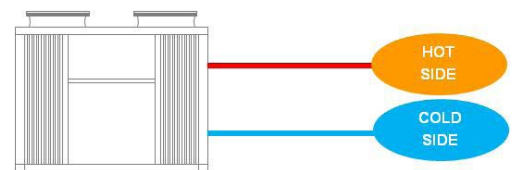

360° of efficiency

During a whole year and during the same day heating and cooling demand hugely vary with hot-cool combinations very unstable, function of many factors, among others: latitude and altitude of installation, building features and functionalities of different ambient.

Unit will mainly work in simultaneous heating-cooling mode with varying combinations over the time.

Clivet unit distinguishes for this working mode offering the best efficiency performance thanks to used solutions.

Refrigerant scheme allows both the partial and the total recovery mode for the MULTIFUNCTION heat exchanger according to thermal energy required.

Completely automatic set-up and system control logic adjusts the mode according the most efficient performance.

Completely automatic set-up and system control logic adjusts the mode according the most efficient performance. During a whole year more than half of enery provided is produced during unbalanced capacity demand where MULTIFUNCTION offer the best performances. Using the heat exchanger as a partial recovery device drives to an higher efficiency of 5% compared to solutions not using this working mode.

Real benefits in terms of efficiency and reliability:

- Few mode switches, reset where thermal capacity is less than 25% of cooling capacity;
- Improved reliability thanks to modulation and without on-off switches;
- Precise set-up thanks to modulation with less mode switches;
- Additional 3% savings on annual energy consumption comparing to standard multifunction units.

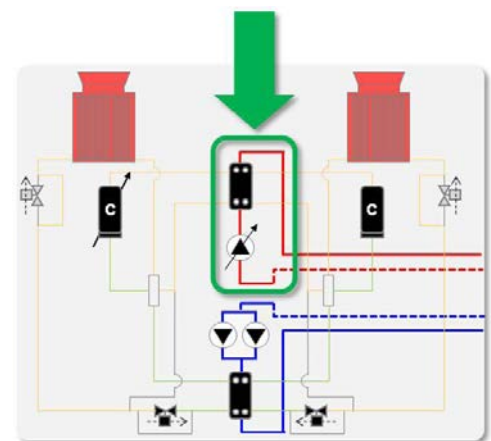
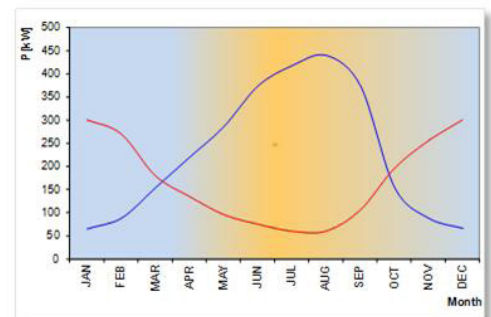

High seasonal efficiency thanks to the capacity continuous modulation

The progressive and sequential activation of the two refrigeration circuits, one controlled by inverter technology, guarantees the complete adjustment to the installation load.

The capacity modulation is necessary starting from minimum values which guarantee the continuous capacity supply depending on the requirements.



Control of the refrigerant flow

The load variability involves the continuous variation of the refrigerant volume moved by compressors.

The **electronic expansion valve (EEV)**, standard on Clivet units, adapts rapidly and precisely to the actual load required for usage, allowing stable and reliable control in comparison with mechanical thermostatic valves (TEV). This results also in a **further increase in efficiency and longer compressor life**.

The overheating control allows preventing phenomena that are hazardous to the compressors, such as overtemperature and return fluids, thereby increasing even more efficiency and durability.

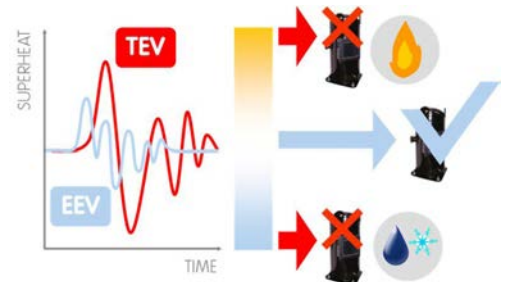

Efficient heat exchange

The **new plate exchanger design** allows an higher evaporating temperature, guaranteeing a better exchange efficiency, above all in the part-load operating that coincides with the most of the unit operating time.

The **coil hydrophilic aluminium coating** allows a faster water drop elimination and consequently a better flow distribution, reducing the defrosting time and increasing the exchange efficiency.

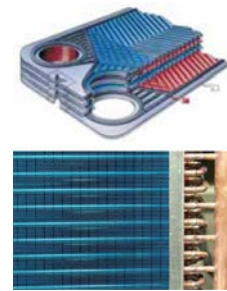

Standard supplied ECOBREEZE fans, electronically controlled

With ECOBREEZE, the electric motor with an external rotor is driven by the continuous magnetic switching of the stator, deriving from the integrated electronic control.

The advantages are:

- **70% increase in efficiency** thanks to the brushless technology and the special electricity supply;
- **increase in the working life**, thanks to the elimination of the brush wear;
- **reduction in the electrical consumption by the system**, thanks to a drastic reduction of the inrush current for the fans obtained using the integrated 'Soft starter' function.



Fans at variable speed for minimal noise emission

All units are supplied with a **condensation electronic control**. It automatically reduces the fan speed as the heat load drops.

Since the fans are the unit's main noise source, the benefits are evident especially during the night hours, when the load is reduced but sensitivity to noise is enhanced.

All this translates into a reduction of **sound pressure down to 8 dB(A)** compared to full load operation in 90% of operating time of the unit.

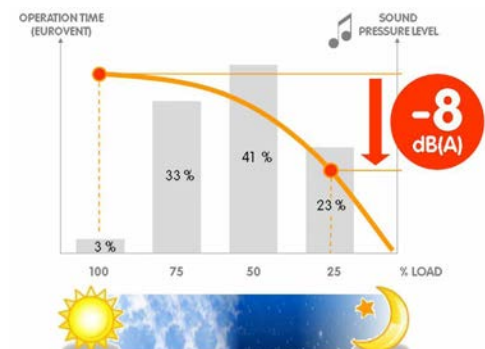

Efficient and silent ventilation technology (optional)

It is possible to further increase the seasonal efficiency with the innovative air handling system on the external exchangers.

The new AxiTop diffuser creates an ideal air distribution: it aerodynamically decelerates the flow and transforms a big part of its kinetic energy in static pressure.

All AXITOP components are aerodynamically optimized enhancing significantly the efficiency and reducing the impeller speed and consequently the noise.

Obtaining:

- down to -3 dB of silence
- reduction of 3% of the absorbed energy

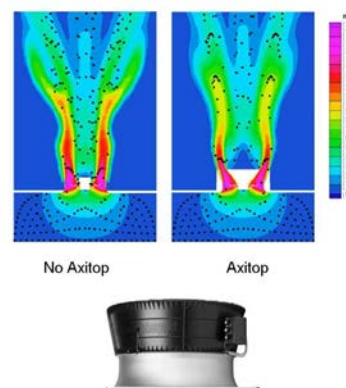

Water flow-rate continuous modulation (optional)

The energy used for the vector pumping is fundamental on the seasonal efficiency.

The VARYFLOW + modulating pumping unit made up of two pumps in parallel controlled by inverter, allows a precise water flow-rate modulation reducing notably the consumptions and at the same time it guarantees its functionality also in case of temporary unavailability of one of the two pumps, guaranteeing about the 80% of the nominal flow-rate.

The water flow-rate modulation can be managed in function of the installation pressure or keeping constant the delta between return and supply temperature.

If the installation water temperature is in critical conditions, **VARYFLOW+** allows to extend the ELFOEnergy Magnum operating ranges guaranteeing the operating.

In case of particular installation needs, the hydronic assemblies are also available:

- **ON/OFF pump:** the traditional solution with high available pressure.
- **ON/OFF pump + ON/OFF pump in stand-by:** the solution that favours reliability. The built-in control balances the operating hours of the two pump and in case of any failure it signals the damage and automatically activates the stand-by pump.

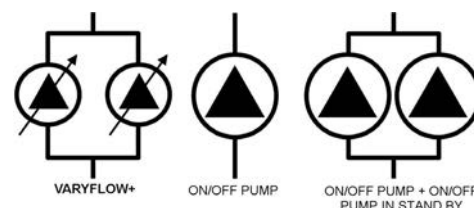

Built-in inertial accumulation available

Available only for size 35.2 - 45.2.

In most Magnum systems it can be installed without inertial accumulation on the system. In fact, the unit quickly adapts to the load due to modular compressors, electronic thermostatic valve and low water content plate heat exchangers. However, in the event of hydraulic distribution networks with reduced dimensions, it is important to provide the system with a hydraulic flywheel. In such cases, inertial accumulation is available built-in, equipped with insulating coating and all the necessary safety devices. This allows eliminating installation times and costs and freeing space inside the building.

Advanced control

The control system combines in a single solution the operating efficiency and the user-friendliness. Continuously monitoring all of the unit operating parameters, it ensures the maintenance of an optimal energy efficiency. The control includes many safety functions and a complete alarm management.

It also includes advanced functions, such as daily and weekly programming and automatic maximum power consumption limitation (demand limit).

It allows the management of several units in cascade up to 1 master and 6 slave (Ecoshare)

The interface terminal is equipped with a backlit graphic display and a multifunction access keyboard. The multilevel menu is protected by different passwords according to the type of user.



Remote control (optional)

The remote control allows accessing to the same functions that are accessible by the built-in unit user interface, and can be installed at a maximum distance of 350 meters.



Smart management of defrosts

The automatic defrost cycles on the remaining external exchanger surface are managed in ALTERNATED mode for each refrigeration circuit, guaranteeing the 50% of the delivered capacity. The built-in electronic control analyzes not only the external conditions but also the evaporating pressure variations in the exchanger.

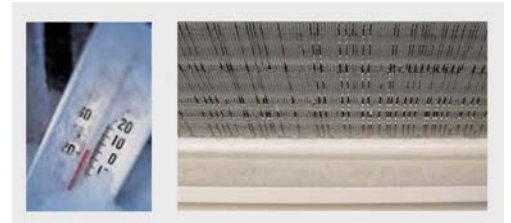

Coils protected against the formation of ice

The particular technology of the heat pump developed by Clivet guarantees its continued and reliable operation.

The ICE PROTECTION SYSTEM device prevents icing on the base of the external exchanger during winter operation, thanks to a special subcooling circuit. This prevents damages caused by freezing.

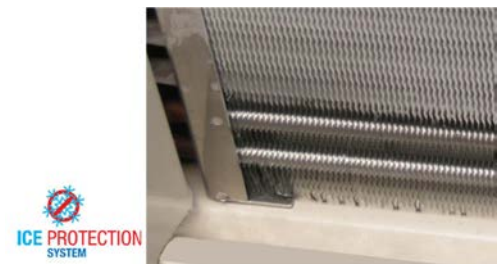

Remote system management

Magnum is standard equipped with:

- potential-free contact for remote on-off control
- potential-free contacts for remote display of the compressor status
- setting from user interface: Off / local On / serial On
- potential-free contact to remote any possible alarm

Thanks to the different communication protocols available, the unit is able to exchange information with the main supervisory systems using serial connections.



Controlled power supply

Proper power supply ensures optimal unit operation and protects its many electrical components.

The phase monitor, standard supplied:

- controls the presence and the exact sequence of the phases
- checks any voltage anomalies (-10%)
- automatically restarts the unit as soon as the proper power supply is restored.



Modularity

In the event of particularly large buildings requiring high capacities, it is advisable to use several units.

The Magnum units are designed to be connected in parallel in modular logic, thereby granting the following advantages:

Increased flexibility, enhanced by the control that can adapt to the load

increased reliability, since the malfunction of one unit does not compromise the capacity supply of the other units.

Increased efficiency, since energy is produced where and when required, according to the served area.

The microprocessor control combined with ECOSHARE allows controlling up to 7 units in local network (1 Master unit and 6 Slave).

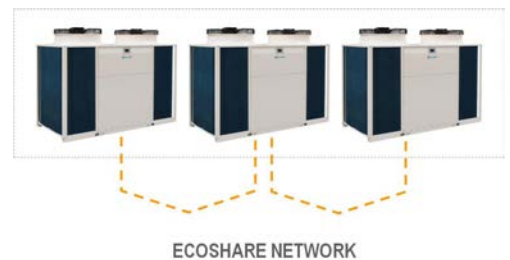

Compact unit

All these distinctive elements are included in only **one packaged solution**.

The new design **reduces the overall dimensions** and allows a **simplified access**, both front and rear, allowing a **quick maintenance**.



Standard unit technical specifications

Compressor

First circuit: Hermetic scroll compressor, complete with motor over-temperature and over-current devices and protection against excessive gas discharge temperature. Fitted on rubber antivibration mounts and complete with oil charge. The automatic oil heater prevents the oil from being diluted by the refrigerant when the compressor stops.

Second circuit: Hermetic orbiting scroll compressor, complete with motor over-temperature and over-current devices and protection against excessive gas discharge temperature. Fitted on rubber antivibration mounts and complete with oil charge. The automatic oil heater prevents the oil from being diluted by the refrigerant when the compressor stops.

Structure

Supporting structure realised with steel frame with zinc-magnesium superficial treatment painted with polyester powder RAL 9001, that ensures excellent mechanical features and high long-term resilience against corrosion.

Panelling

External pre-painted zinc-magnesium panelling that ensures superior resistance to corrosion for outdoor installation and eliminates the need for periodical painting. The panels can be easily removed to fully access internal components and are lined with sound-proof material on the inside to contain the unit's sound levels.

Internal exchanger

Direct expansion heat exchanger, braze-welded AISI 316 stainless steel plates with large exchange surface and complete with external heat and anti-condensate insulation.

The exchanger is complete with:

- differential pressure switch, water side
- antifreeze heater to protect the water side exchanger, preventing the formation of frost if the water temperature falls below a set value.

External exchanger

Direct expansion finned coil exchanger made with copper pipes placed on staggered rows mechanically expanded to better adhere to the fin collar. The fins are made from aluminium with a hydrophilic treatment and a corrugated surface. They are appropriately distanced to ensure the maximum heat exchange efficiency.

Fan

Axial fans with sickle profile blades terminating with "Winglets", directly coupled to the electronic controlled motor (IP54), driven by the magnetic switching of the stator. The brushless technology and the special supply increase both the life expectancy and the efficiency. As a result the electric consumption is reduced up to 50%. Fans are located in aerodynamically shaped structures to increase efficiency and reduce noise level. The assembly is protected by accident prevention guards (ECOBREEZE).

Refrigeration circuit

Double refrigeration circuit complete with:

- replaceable anti-acid solid cartridge dehydrator filter
- high pressure safety pressure switch
- low pressure transducer
- high pressure transducer
- non-return valve
- hot gas injection valve
- liquid receiver
- liquid separator
- refrigerant temperature probe
- electronic thermostatic expansion valve
- inversion valve of the 4-way cycle
- high pressure safety valve

Electrical panel

The capacity section includes:

- main door lock isolator switch
- isolating transformer for auxiliary circuit power supply
- on-off scroll compressor protection magnetothermic
- inverter scroll compressor protection fuses
- Inverter, complete with thermal protection, for continuous control of the modulating scroll compressor revolutions
- fan protection fuses and heat protection
- on-off scroll compressor control contactor

The control section includes:

- interface terminal with graphic display
- display of the set values, the error codes and the parameter index
- keys for ON/OFF control, cool and heat operating modes, alarm reset
- proportional-integral water temperature control
- daily, weekly programmer of temperature set-point and unit on/off
- Set point compensation in function of the outdoor air temperature
- set-point compensation with 0-10 V signal
- unit switching on management by local or remote (serial)
- antifreeze protection water side
- compressor overload protection and timer
- prealarm function for water antifreeze and high refrigerant gas pressure
- self-diagnosis system with immediate display of the fault code
- automatic rotation control for compressor starts
- compressor operating hour display
- Input for remote ON/OFF control
- relay for remote cumulative fault signal
- inlet for demand limit (power input limitation according to a 0÷10V external signal)
- Digital input for double set-point enabling
- potential-free contacts for compressor status
- Phase monitor
- ECOSHARE feature to automatically manage a group of units
- 0÷10V signal output and potential-free contact for auxiliary heater
- enabling of DHW preparation in relation to remote consent
- numeration of electrical panel cables

Unit equipment with low outdoor temperatures

Minimum outdoor air temperature	Operating unit		Unit in stand-by *** (fed unit)	Unit in storage (unit not fed)
	Cool*	Heat**		
+11°C	√ standard unit	√ standard unit	√ standard unit	√ standard unit
+2°C				
-5°C				
-7°C				
-10°C				
Between -10°C and -15°C	NOT POSSIBLE	√ glycol in an appropriate percentage (1)	√ glycol in an appropriate percentage (1)	NOT POSSIBLE
Between -15°C and -20°C	NOT POSSIBLE	√ glycol in an appropriate percentage (1) X not compatible with Clivet integrated pumping device	√ glycol in an appropriate percentage (1) X not compatible with Clivet integrated pumping device	NOT POSSIBLE

Data referred to the following conditions:

* chilled water production:

internal exchanger water = 12/7°C

** hot water production:

internal exchanger water = 30/35 °C

*** consider the unit powered electrically, with active control on pumping units. It is recommended to set a set-point value lower than standard (eco mode)

1. Operating range where the water pumping unit must be powered and always active, or with a periodical activation of the outdoor temperature operating pump to guarantee the correct unit operation.

At the unit start-up the water temperature or water with glycol must be inside the operating range indicated in the "Operating range" graph.

To know the water freezing temperature on varying the glycol percentage refer to the specific 'Correction factors for glycol use' table.



Air conditions which are at rest are defined as the absence of air flowing towards the unit. Weak winds can induce air to flow through the exchanger and air-levels which can cause a reduction in the operating range. In the presence of predominant winds it is necessary to use suitable windbreak barriers.

4T configuration - For 4-pipe systems

4T configuration supply air conditioning systems with 4 tubes and it is able to supply hot water and chilled water simultaneously and independently on season.

This configuration allows:

- Simultaneous hot water production to the hot user side with chilled water production to the cold user side;
- Hot water production to the hot user side with cooling capacity rejection to the external thermal source;
- Chilled water production to the cold user side with heating capacity rejection to the external thermal source.

Unit controller guarantees unit operation in mix mode conditions.

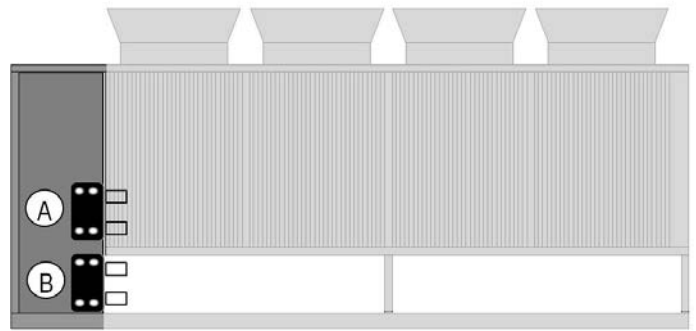

A: cold user side exchanger
B: hot user side exchanger

Considerations on the installation

Desuperheater mode

The standard unit control at part load changes the water flow-rate, hot side, maintaining the supply temperature at the target value. Through the flow modulation the standard unit can produce hot water even over the set-point, up to a settable limit temperature (default 65°C). Thanks to this setting the exchanger operation time, hot user side, is extended in desuperheater mode, improving the unit efficiency of 5% compared to the desuperheater mode not active.



The logic of control above described drives to a proper design of hydraulic components and safety devices, considering the upper limit of hot water. It is possible to decrease this temperature down to the set point, not having the energy efficiency benefits that desuperheater solution leads.

System water volume

For a proper operation of MULTIFUNCTION 4T unit is necessary to contemplate a correct design of water tanks both on cold user side and hot user side.

Minimum system water volumes are described within 'General technical data' section and they have to be satisfied to avoid continuous compressor switching on and off.

We recommend to double minimum water volumes described for small deviations from set-point and a stable operation mode even in the most extreme conditions, such as simultaneously to an huge heating capacity demand there is a small cooling capacity demand.

Operation with water low temperatures on the exchanger, recovery side

When the hot water production function is enabled to the recovery but the water temperature is too low, the water produced to the recovery will have a temperature higher than the minimum level indicated in the graph. If this unit operating requirement is not acceptable, it is recommended to provide on the recovery side a primary - secondary where the secondary is maintained at the desired operating temperature while the primary will have a consistent operating temperatures within the limits shown in the graph

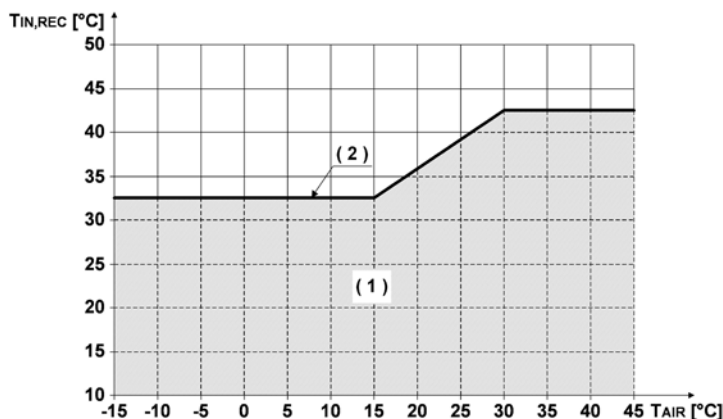

TIN,REC [°C] = Entering water temperature to recovery
TAIR [°C] = Entering external exchanger air temperature (D.B.)

1. Transient operating range where unit operates forcing on the recovery set-point (if the recovery function is enabled)
2. Minimum system water temperature level, recovery side

Hot side water flow-rate

When pumps are not built-in it is necessary to contemplate hot user side water flow-rate modulation, managed by the unit with a 0-10V signal.

Cold side water flow-rate

For a correct unit operation in all the possibile circuit switching, it is necessary to ensure the water flow-rate, cold side, even when usually chilled water is not requested. This results in maintaining in stand-by and available the pump at the primary circuit start-up in the cold season. If the pumping unit may not be installed built-in, the external pumps start signal must be managed by the unit taking it from the specific potential-free contact in the electrical panel.

4-pipes unit operating range

The unit is capable of producing chilled or hot water at the same time throughout the year. Chilled water is only produced on the cold side. Hot water is only produced on the hot side.

By providing the unit with an DHW switching valve (VACSR) it is possible to prioritise domestic hot water production over system side heating requirements.

Example of how the unit operates:

Cooling requirement 100%, Heating requirement 0%:

In this condition all the cooling capacity is released to the cold side of the heat exchanger and maintenance of the cold side set point is ensured through the modulation of the capacity steps.

All the heating capacity is dispersed on the finned coil exchanger. The pump control on the hot side may be activated or deactivated based on a schedule to keep water temperature under control.

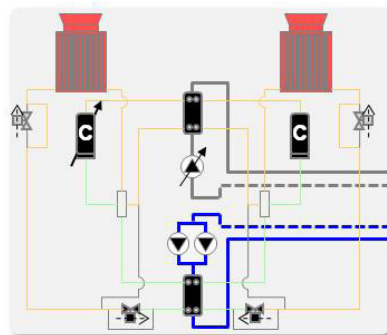

Cooling requirement 0%, Heating requirement 100%:

In this condition all the heating capacity is released to the hot side of the heat exchanger and maintenance of the hot side set point is ensured through the modulation of the capacity steps.

All the cooling capacity is dispersed on the finned coil exchanger. Cooling capacity is not released on the cold side: the cold side pump control may be kept activated at a minimum or it may be activated and deactivated based on a regular schedule to keep water temperature under control.

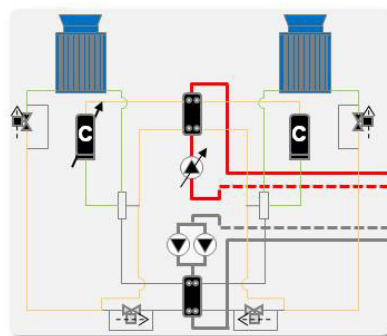

Cooling requirement 100%, Heating requirement 100%:

In this condition all the cooling capacity is released to the cold side of the heat exchanger while all the heating capacity is released to the hot side of the heat exchanger.

Maintenance of the hot side/cold side set point is ensured through the modulation of the capacity steps, according to the operation mode used (hot side in winter operation, cold side in summer operation).

In this condition, the overall efficiency of the unit, defined as (chiller power for cold operation + heating power for recovery)/(total power input) is very high.

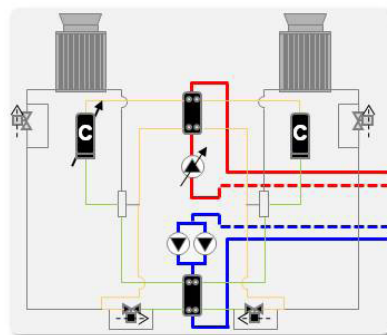

Configuration for 4-pipe system

Unit configuration

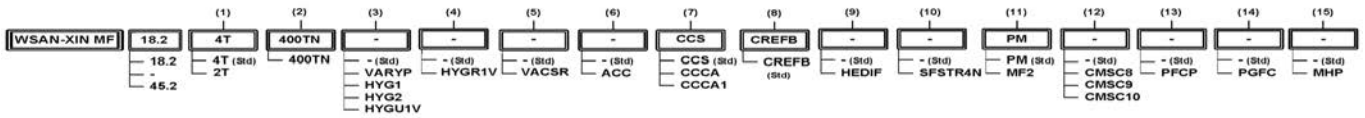

(1) Functionalities

4T - Unit for four-pipe systems (standard)
2T - Unit for reversible 2-pipe system

(2) Supply voltage

Supply voltage 400/3/50+N (standard)

(3) Cold side hydronic assemblies

Refer to the diagrams of the hydronic assembly reported

(4) Hot side hydronic assemblies

Refer to the diagrams of the hydronic assembly reported

(5) Hot side DHW switching valve

Refer to the diagrams of the hydronic assembly reported

(6) Storage tank

(-) not required (standard)
ACC - Storage tank (only for size 35.2 - 45.2)

(7) Condenser coil

CCS - Standard condenser coil (standard)
CCA - Copper / aluminium condenser coil with acrylic lining
CCA1 - Condenser coil with Aluminum Energy Guard DCC treatment

(8) Fan type

CREFB - ECOBREEZE external section fans consumption reduction device (Standard)

(9) Diffuser for fan

(-) not required (standard)
HEDIF - Diffuser for high efficiency axial fan

(10) Soft starter

(-) not required (standard)
SFSTR4N - Disposal for inrush current reduction, for unit 400/3/50+N

(11) Phase monitor

PM - Phase monitor (standard)
MF2 - Multi-function phase monitor

(12) Serial communication module

(-) not required (standard)
CMSC8 - Serial communication module for BACnet supervisor
CMSC9 - Serial communication module for Modbus supervisor
CMSC10 - Serial communication module for LonWorks supervisor

(13) Power Capacitors

(-) not required (standard)
PFCP - Power factor correction capacitors (cosfi > 0.9)

(14) Protection grill

(-) not required (standard)
PGFC - Finned coil protection grill

(15) High and low pressure gauges

(-) not required (standard)
MHP - High and low pressure gauges

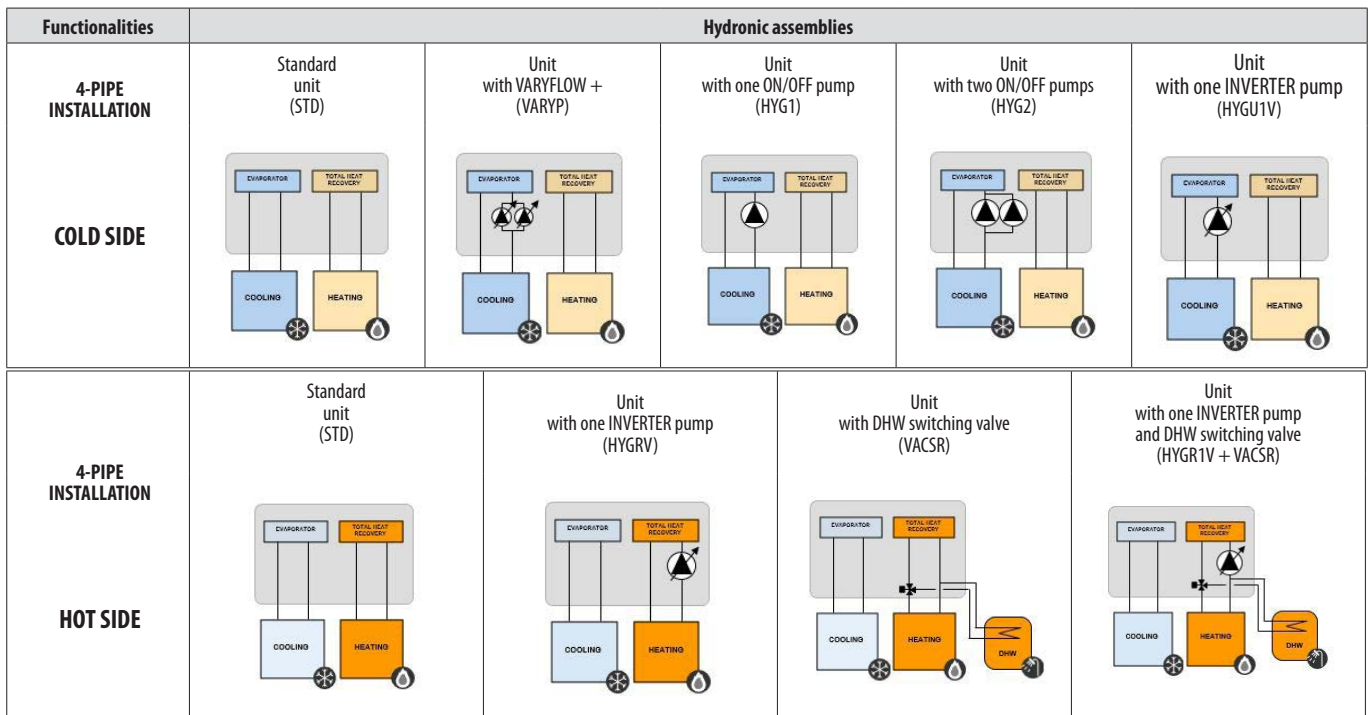

The unit may be configured by choosing one of the four user side hydronic assembly combinations with one of the four recovery side combinations depending on system requirements.

Accessories separately supplied			
<ul style="list-style-type: none"> RCTX - Remote control 	<ul style="list-style-type: none"> BACK - BACnet serial communication module CMMBX - Serial communication module to supervisor (Modbus) CMSLWX - LonWorks serial communication module 	<ul style="list-style-type: none"> PGFCX - Finned coil protection grill IFWX - Steel mesh strainer on water side 	<ul style="list-style-type: none"> AVIBX - Anti-vibration mount support MHPX - High and low pressure gauges

Configuration for 4-pipe system

General technical data - Performance

Size			18.2	20.2	25.2	30.2	35.2	40.2	45.2
Cooling 100% - Heating 0%									
Cooling capacity	1	kW	49,8	59,6	69,7	82,5	92,8	106	120
Compressor power input	1	kW	14,5	18,1	20,5	25,6	30,4	35,0	42,2
Total power input	2	kW	16,7	20,3	23,4	28,5	33,3	38,4	45,6
EER	1		2,98	2,94	2,98	2,90	2,79	2,76	2,63
Water flow-rate	1	l/s	2,34	2,85	3,33	3,94	4,43	5,06	5,73
Cold side exchanger pressure drop factor	1	kPa	15	21	14	20	16	21	19
Cooling capacity (EN14511:2013)	3	kW	49,6	59,3	69,5	82,2	92,5	106	120
Total power input (EN14511:2013)	3	kW	16,9	20,6	23,6	28,8	33,6	38,8	46,0
EER (EN14511:2013)	3		2,93	2,88	2,94	2,85	2,75	2,72	2,60
SEER	9		3,34	3,43	3,47	3,63	3,72	3,70	3,79
Cooling 0% - Heating 100%									
Heating capacity	4	kW	56,8	69,4	79,4	94,5	108	125	142
Compressor power input	4	kW	14,7	18,3	20,8	25,3	29,2	33,5	38,8
Total power input	2	kW	16,9	20,5	23,7	28,2	32,1	36,9	42,2
COP	4		3,36	3,38	3,35	3,35	3,37	3,37	3,36
Water flow-rate	4	l/s	2,71	3,31	3,79	4,51	5,17	5,95	6,77
Hot side exchanger pressure drop factor	4	kPa	41	50	53	52	41	42	47
Heating capacity (EN14511:2013)	5	kW	57,1	69,8	79,7	94,9	109	125	143
Total power input (EN14511:2013)	5	kW	17,2	20,9	24,0	28,6	32,7	37,5	42,9
COP (EN14511:2013)	5		3,32	3,34	3,32	3,32	3,32	3,33	3,32
ErP Space Heating Energy Class - AVERAGE Climate - W35	8		A+	A+	A+	A+	-	-	-
SCOP - AVERAGE Climate - W35	9		3,69	3,74	3,59	3,75	3,83	3,80	3,96
Cooling 100% - Heating 100%									
Cooling capacity	6	kW	49,9	59,8	69,7	82,9	95,9	109	128
Heating capacity	6	kW	64,7	77,7	90,4	107	125	141	167
Total power input	6	kW	14,8	17,9	20,7	24,5	28,7	32,7	38,3
Overall efficiency	7		7,73	7,69	7,72	7,76	7,69	7,66	7,71
Cold side exchanger water flow rate	6	l/s	2,38	2,86	3,33	3,96	4,58	5,20	6,13
Cold side exchanger pressure drop factor	6	kPa	15	21	14	20	17	22	22
Hot side exchanger water flow rate	6	l/s	3,09	3,71	4,32	5,14	5,95	6,76	7,96
Hot side exchanger pressure drop factor	6	kPa	52	62	67	66	53	53	65

The Product is compliant with the Erp (Energy Related Products) European Directive. It includes the Commission delegated Regulation (EU) No 811/2013 (rate heat output ≤ 70 kW at specified reference conditions) and the Commission delegated Regulation (EU) No 813/2013 (rated heat output ≤ 400 kW at specified reference conditions).

*Contains fluorinated greenhouse gases (GWP 2087,5)

1. Data referred to the following conditions: cold side exchanger water = 12/7 °C. Entering external exchanger air temperature 35°C. Evaporator fouling factor = $0.44 \times 10^{(-4)}$ m² K/W
2. The Total Power Input value does not take into account the part related to the pumps and required to overcome the pressure drops for the circulation of the solution inside the exchangers
3. Data compliant to Standard EN 14511:2013 referred to the following conditions: cold side exchanger water temperature = 12/7°C. Entering external exchanger air temperature 35°C
4. Data referred to the following conditions: hot side exchanger water = 40/45 °C. Entering external exchanger air temperature = 7°C D.B./6°C W.B.
5. Data compliant to Standard EN 14511:2013 referred to the following conditions: hot side exchanger water temperature = 40/45 °C. Entering external exchanger air temperature = 7°C D.B./6°C W.B.
6. Data referred to the following conditions: exchanger water cooling side = 12/7 °C. exchanger water heating side = 40/45°C
7. Global efficiency, calculated as (Cooling capacity + Heating capacity)/(Total power input).
8. Seasonal Space Heating Energy Efficiency Class according to Commission delegated Regulation (EU) No 811/2013. W = Water outlet temperature (°C)
9. Data calculated according to the EN 14825:2016 Regulation

Configuration for 4-pipe system

General technical data - Construction

Size			18.2	20.2	25.2	30.2	35.2	40.2	45.2
Compressor									
Type of compressors			SCROLL INVERTER + SCROLL ON/OFF						
Refrigerant			R-410A						
No. of compressors		No	2	2	2	2	2	2	2
Oil charge (C1)		l	3,0	3,3	3,3	3,6	3,6	6,7	6,7
Oil charge (C2)		l	3,3	3,3	3,3	3,6	3,6	3,6	6,7
Refrigeration circuits		No	2	2	2	2	2	2	2
Refrigerant charge (C1)	1	kg	11,0	11,0	11,0	14,5	14,5	17,5	17,5
Refrigerant charge (C2)	1	kg	11,0	11,0	11,0	14,5	14,5	17,5	21,0
User side exchanger									
Type of exchanger	2		PHE						
No. of exchangers		No	1	1	1	1	1	1	1
Water content		l	9,70	9,70	14,5	14,5	15,8	15,8	19,3
User side minimum system water content	4	l	360	424	503	587	673	762	863
Recovery side exchanger									
Type of exchanger	2	No	PHE						
No. of exchangers		l	2	2	2	2	2	2	2
Water content			9,40	9,90	10,4	11,7	14,4	16,4	18,5
Recovery side minimum system water content	4	l	410	488	573	673	780	890	1021
External Section Fans									
Type of fans	3		EC						
No. of fans		No	2	2	2	2	2	2	2
Standard airflow		l/s	10556	10556	13056	13056	13333	14167	14167
Installed unit power		kW	1,1	1,1	1,4	1,4	1,5	1,7	1,7
Connections									
Water fittings			2"	2"	2" 1/2	2" 1/2	2" 1/2	2" 1/2	2" 1/2
Water circuit									
Maximum water side pressure		kPa	1000	1000	1000	1000	1000	1000	1000
Safety valve calibration		kPa	600	600	600	600	600	600	600
Power supply									
Standard power supply			400/3/50+N	400/3/50+N	400/3/50+N	400/3/50+N	400/3/50+N	400/3/50+N	400/3/50+N

1. Indicative values for standard units with possible +/-10% variation. The actual data are indicated on the label of the unit.

2. PHE = Plate exchanger

3. EC = Axial-flow fan + EC

4. The minimum system water content calculated value does not consider the internal exchanger water content. With outdoor air low temperature applications or low medium requested loads, the minimum installation water volume is obtained doubling the indicated value.

Configuration for 4-pipe system

Electrical data

Supply voltage 400/3/50+N

Size		18.2	20.2	25.2	30.2	35.2	40.2	45.2
F.L.A. - Full load current at max admissible conditions								
F.L.A. - Compressor 1 (ON/OFF)	A	16,8	24,3	26,6	30,8	30,8	40,6	40,6
F.L.A. - Compressor 2 (INVERTER)	A	20,8	20,8	23,3	29,5	32,1	32,1	40,5
F.L.A. - Single External Fan	A	3,9	3,9	3,9	3,9	3,9	3,9	3,9
F.L.A. - Total	A	45,5	52,9	57,7	68,1	70,7	80,5	88,9
L.R.A. - Locked rotor amperes								
L.R.A. - Compressor 1 (ON/OFF)	A	98,0	147	158	197	197	215	215
L.R.A. - Compressor 2 (INVERTER)	A	20,8	20,8	23,3	29,5	32,1	32,1	40,5
F.L.I. - Full load power input at max admissible conditions								
F.L.I. - Compressor 1 (ON/OFF)	kW	9,70	14,6	16,5	18,5	18,5	24,8	24,8
F.L.I. - Compressor 2 (INVERTER)	kW	12,7	12,7	14,6	18,0	19,6	19,6	26,7
F.L.I. - Single External Fan	kW	2,56	2,56	2,56	2,56	2,56	2,56	2,56
F.L.I. - Total	kW	27,5	32,5	36,3	41,6	43,3	49,6	56,6
M.I.C. Maximum inrush current								
M.I.C. - Value	A	126,6	175,6	189,1	234,3	237,0	255,0	263,3
M.I.C. - With soft start accessory	A	77,6	102,1	110,1	135,8	138,4	147,4	155,8

Power supply: 400/3/50 Hz. Voltage variation: max. +/-10%

Voltage unbalance between phases: max 2 %

For non standard voltage please contact Clivet technical office

Units are in compliance with the european law CEI EN 60204 and CEI EN 60335.

Sound levels

Standard unit

Size	Sound power level (dB)								Sound pressure level dB(A)	Sound power level dB(A)
	Octave band (Hz)									
	63	125	250	500	1000	2000	4000	8000		
18.2	90	83	78	80	78	72	67	61	65	82
20.2	89	82	80	81	77	72	64	59	65	82
25.2	90	83	80	81	79	74	68	60	66	83
30.2	91	84	82	83	78	75	66	59	66	84
35.2	91	85	82	84	79	74	67	61	68	85
40.2	92	85	83	84	80	75	67	62	68	85
45.2	94	86	83	84	82	77	71	63	69	86

Sound levels refer to units with full load under nominal test conditions.

The sound pressure level refers to a distance of 1 meter from the outer surface of the unit operating in open field.

Noise levels are determined using the tensiometric method (UNI EN ISO 9614-2)

Data referred to the following conditions:

entering / leaving exchanger water temperature user side 12/7°C

entering / leaving exchanger water temperature source side 30/35°C

Unit with HEDIF - "Diffuser for high efficiency axial fan" option

Size	Sound pressure level	Sound power level
	dB(A)	dB(A)
18.2	63	80
20.2	63	80
25.2	64	81
30.2	64	82
35.2	66	83
40.2	66	83
45.2	67	84

Sound levels refer to units with full load under nominal test conditions.

The sound pressure level refers to a distance of 1m from the outer surface of the unit operating in an open field.

Noise levels are determined using the tensiometric method (UNI EN ISO 9614-2)

Data referred to the following conditions:

internal exchanger water = 12/7°C

ambient temperature = 35 °C

Configuration for 4-pipe system

Operating range - Cooling

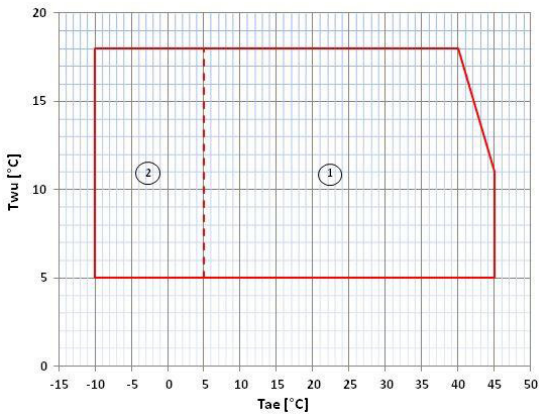

T_{wu} [°C] = Internal exchanger outlet water temperature
 T_{ae} [°C] = External exchanger inlet air temperature

1. Standard unit operating range at full load
2. Standard unit operating range with air flow automatic modulation

Operating range - Heating

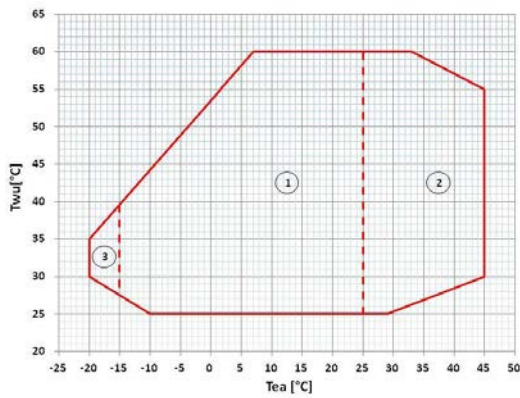

T_{wu} [°C] = Water outlet temperature at the recovery side of the heat exchanger
 T_{ae} [°C] = External exchanger inlet air temperature

1. Standard unit operating range at full load
2. Standard unit operating range with air flow automatic modulation
3. Unit operating range with automatic staging of the compressor capacity not compatible with Clivet integrated pumping unit (HYG1 - HYG2 - VARYP - HYGR1V)

Operating range - Cooling 100% - Heating 100%

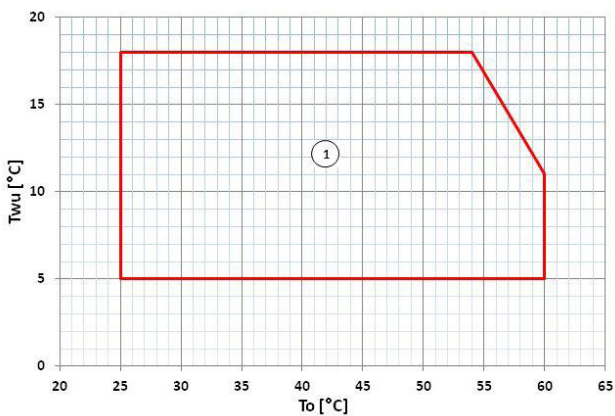

T_{wu} [°C] = Water outlet temperature from the user side of the heat exchanger (2-4 pipes)
 T_o [°C] = Outlet water temperature at the heat exchanger recovery side (2-4 pipes)

1. Standar unit operating range

Configuration for 4-pipe system

Performances in cooling

Size	To (°C)	Entering external exchanger air temperature (°C)											
		20		25		30		35		40		45	
		kWf	kWe	kWf	kWe	kWf	kWe	kWf	kWe	kWf	kWe	kWf	kWe
18.2	5	52,6	10,9	50,5	12,0	48,3	13,1	46,4	14,3	42,1	15,8	38,1	17,7
	7	56,3	11,1	54,1	12,2	51,8	13,3	49,8	14,5	45,0	16,1	40,8	18,0
	10	62,1	11,4	59,8	12,5	56,9	13,6	54,7	14,9	49,5	16,4	44,9	18,3
	12	65,8	11,7	63,2	12,7	60,2	13,8	57,7	15,1	52,1	16,6	-	-
	15	71,6	12,0	68,9	13,0	65,4	14,2	62,7	15,4	56,7	16,9	-	-
	18	77,7	12,3	74,6	13,4	70,8	14,5	67,7	15,8	61,3	17,3	-	-
20.2	5	63,2	13,6	60,9	14,9	58,0	16,3	55,5	17,8	50,4	19,6	45,8	22,0
	7	67,4	13,9	64,9	15,2	62,0	16,6	59,6	18,1	53,9	20,0	49,0	22,4
	10	74,4	14,3	71,5	15,6	68,1	17,0	65,3	18,6	59,1	20,4	54,2	22,7
	12	78,9	14,6	75,5	15,9	71,8	17,4	68,6	18,9	62,0	20,7	-	-
	15	85,6	15,0	82,0	16,3	77,6	17,8	74,2	19,4	67,4	21,2	-	-
	18	92,6	15,5	88,8	16,8	84,0	18,3	80,1	19,8	72,4	21,8	-	-
25.2	5	75,3	15,5	72,5	16,9	69,1	18,5	65,6	20,3	59,8	22,3	54,1	25,1
	7	80,3	15,8	77,0	17,2	73,3	18,8	69,7	20,5	63,5	22,6	57,4	25,3
	10	88,0	16,3	84,3	17,6	80,5	19,2	76,1	21,0	69,4	23,0	63,3	25,7
	12	92,9	16,6	89,2	18,0	84,8	19,6	80,3	21,3	73,3	23,3	-	-
	15	101	17,1	97,2	18,5	92,0	20,1	86,7	21,9	79,2	23,9	-	-
	18	109	17,7	104	19,1	98,9	20,6	93,0	22,3	85,1	24,4	-	-
30.2	5	89,2	19,7	86,5	21,4	82,2	23,1	77,6	25,2	71,0	27,7	64,4	30,9
	7	94,9	20,1	91,8	21,8	87,2	23,6	82,5	25,6	75,2	28,1	68,5	31,2
	10	104	20,8	100	22,5	95,0	24,4	89,5	26,4	81,5	28,9	75,3	32,0
	12	110	21,3	106	23,0	100	24,8	94,0	26,9	86,3	29,2	-	-
	15	119	22,0	115	23,6	108	25,5	102	27,6	93,1	30,3	-	-
	18	128	22,8	123	24,4	116	26,2	109	28,4	99,9	31,0	-	-
35.2	5	102	23,6	99,1	25,5	93,6	27,5	88,1	29,9	80,4	32,8	73,7	36,4
	7	109	24,1	105	26,0	98,7	28,1	92,8	30,4	84,6	33,3	78,2	36,8
	10	118	25,0	114	26,9	107	28,8	101	31,2	91,9	34,3	86,9	37,6
	12	126	25,5	121	27,5	114	29,5	107	31,9	98,0	34,8	-	-
	15	137	26,5	132	28,5	123	30,4	116	32,8	106	36,0	-	-
	18	146	27,3	139	29,3	131	31,3	123	33,6	114	36,6	-	-
40.2	5	118	26,6	114	28,9	108	31,4	101	34,3	92,1	37,8	84,3	41,8
	7	125	27,2	121	29,4	114	32,0	106	35,0	97,3	38,2	89,7	42,3
	10	136	28,1	131	30,3	124	32,9	116	35,7	106	39,1	98,8	43,2
	12	144	28,6	138	31,0	130	33,4	122	36,4	111	39,7	-	-
	15	156	29,6	150	31,9	141	34,4	131	37,3	120	40,9	-	-
	18	168	30,6	161	32,9	151	35,5	141	38,4	130	41,8	-	-
45.2	5	135	31,8	130	34,8	122	37,9	114	41,6	104	45,8	95,0	51,3
	7	142	32,5	136	35,5	128	38,7	120	42,2	109	46,6	100	51,8
	10	154	33,6	148	36,6	139	39,7	129	43,3	119	47,7	109	52,5
	12	162	34,3	155	37,2	145	40,4	136	44,0	126	48,6	-	-
	15	175	35,5	167	38,4	156	41,7	146	45,4	138	49,7	-	-
	18	188	36,9	179	39,8	167	42,8	157	46,5	145	51,8	-	-

kWf = Cooling capacity at the heat exchanger user side (2 pipes) or cold side (4 pipes) (kW)
 kWe = Electrical power absorbed by compressors (kW)
 To (°C) = outlet water temperature at the heat exchanger user side (2 pipes) or cold side (4 pipes) (°C)
 Performances in function of the inlet/outlet water temperature differential = 5°C

Configuration for 4-pipe system

Performance in Heating

Size	Tae (°C) D.B./W.B	Internal exchanger water outlet temperature (°C)									
		25		35		45		55		60	
		kWt	kWe	kWt	kWe	kWt	kWe	kWt	kWe	kWt	kWe
18.2	-15 / -15.4	31,0	9,26	31,3	11,1	-	-	-	-	-	-
	10 / -10.5	36,9	9,46	37,1	11,4	-	-	-	-	-	-
	-7 / -8	40,2	9,57	40,4	11,5	39,9	13,9	-	-	-	-
	0 / -0.6	49,6	9,89	49,6	11,9	48,0	14,3	-	-	-	-
	7 / 6	59,7	10,2	59,3	12,2	56,8	14,7	52,9	18,3	50,5	19,3
	15 / 13	72,9	10,6	71,9	12,6	68,4	15,1	63,3	18,6	60,5	19,6
	20 / 16	79,6	10,8	78,4	12,8	74,0	15,3	68,1	18,8	65,4	19,8
20.2	-15 / -15.4	39,0	11,6	39,6	14,0	-	-	-	-	-	-
	10 / -10.5	46,0	11,8	46,3	14,3	-	-	-	-	-	-
	-7 / -8	49,9	11,9	50,1	14,4	49,1	17,5	-	-	-	-
	0 / -0.6	61,3	12,3	61,1	14,8	59,1	17,9	-	-	-	-
	7 / 6	73,5	12,7	72,4	15,2	69,4	18,3	65,4	22,7	62,0	24,0
	15 / 13	89,2	13,1	87,7	15,7	83,4	18,8	78,0	23,2	73,8	24,4
	20 / 16	97,1	13,3	95,1	15,9	89,9	19,0	83,7	23,4	79,6	24,6
25.2	-15 / -15.4	44,5	13,2	44,7	15,9	-	-	-	-	-	-
	10 / -10.5	52,5	13,4	52,4	16,2	-	-	-	-	-	-
	-7 / -8	57,1	13,6	56,8	16,4	56,1	20,0	-	-	-	-
	0 / -0.6	70,5	14,0	69,4	16,8	67,4	20,4	-	-	-	-
	7 / 6	84,3	14,4	82,6	17,2	79,4	20,8	74,1	25,9	70,4	27,3
	15 / 13	103	15,0	100	17,8	94,9	21,2	87,8	26,2	83,8	27,6
	20 / 16	112	15,3	109	18,1	103	21,5	94,6	26,4	89,8	27,8
30.2	-15 / -15.4	53,1	15,9	54,0	19,2	-	-	-	-	-	-
	10 / -10.5	62,5	16,3	62,9	19,6	-	-	-	-	-	-
	-7 / -8	67,8	16,5	67,9	19,9	67,1	24,0	-	-	-	-
	0 / -0.6	83,4	17,1	82,7	20,5	80,6	24,7	-	-	-	-
	7 / 6	100	17,7	98,3	21,2	94,5	25,3	88,1	31,1	84,8	32,9
	15 / 13	121	18,5	119	22,0	113	26,0	104	31,8	99,7	33,5
	20 / 16	132	18,9	128	22,3	122	26,4	113	32,1	109	33,9
35.2	-15 / -15.4	61,0	16,5	62,2	22,7	-	-	-	-	-	-
	10 / -10.5	71,9	17,1	72,0	23,1	-	-	-	-	-	-
	-7 / -8	77,8	17,3	77,6	23,3	76,7	28,1	-	-	-	-
	0 / -0.6	96,1	18,2	94,5	24,0	91,8	28,6	-	-	-	-
	7 / 6	115	19,0	112	24,6	108	29,2	101	35,6	90,5	38,8
	15 / 13	140	20,1	136	25,5	129	29,9	119	36,2	108	39,4
	20 / 16	153	20,6	147	25,9	139	30,3	128	36,5	117	39,8
40.2	-15 / -15.4	70,5	22,5	71,5	25,6	-	-	-	-	-	-
	10 / -10.5	82,3	22,8	83,1	26,1	-	-	-	-	-	-
	-7 / -8	89,4	23,1	89,7	26,3	88,7	32,3	-	-	-	-
	0 / -0.6	110	23,7	109	27,0	107	32,9	-	-	-	-
	7 / 6	131	24,3	130	27,7	125	33,5	117	41,2	107	43,5
	15 / 13	159	25,2	156	28,6	149	34,3	138	41,7	124	44,0
	20 / 16	174	25,7	170	29,0	161	34,7	149	42,2	132	44,3
45.2	-15 / -15.4	79,3	23,6	81,3	29,4	-	-	-	-	-	-
	10 / -10.5	93,0	24,2	94,3	30,0	-	-	-	-	-	-
	-7 / -8	100	24,5	102	30,3	102	37,1	-	-	-	-
	0 / -0.6	123	25,4	123	31,2	121	38,0	-	-	-	-
	7 / 6	147	26,3	146	32,1	142	38,8	133	47,7	127	50,2
	15 / 13	179	27,4	175	33,0	168	39,7	156	48,3	149	50,9
	20 / 16	194	27,9	190	33,5	181	40,1	168	48,8	161	51,3

kWt = Heating capacity to the hot side exchanger (kW)

kWe = Electrical power absorbed by compressors (kW)

Tae [°C]: External exchanger inlet air temperature

Performances in function of the inlet/outlet water temperature differential = 5°C

2T configuration - For 2-pipe systems

2T configuration supply air conditioning systems with 2 tubes and it is able to supply hot water or chilled water dependently on season, with the total condensation heat recovery possibility. 2T configuration is designed for air conditioning systems, chilling and heating mode are not allowed.

This configuration allows:

- Simultaneous free hot water production to the recovery side with chilled water production to the user side.
- Hot water production to the recovery side with cooling capacity rejection to the external thermal source.
- Chilled water production to the user side with heating capacity rejection to the external thermal source.
- Hot water production to the user side with cooling capacity rejection to the external thermal source.
- Simultaneous hot water production to the user side and to the recovery side (total heating capacity is the heating capacity declared within 'General technical data' section).

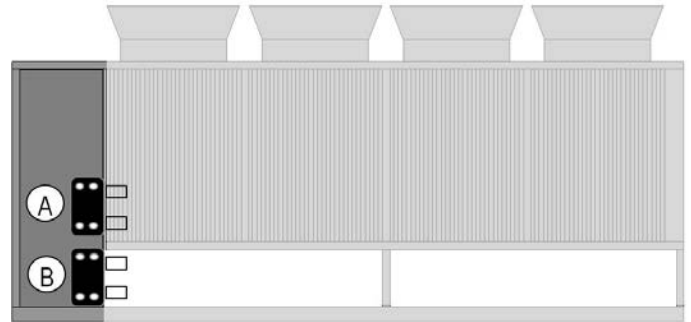

A: user side exchanger
B: recovery exchanger

Unit controller guarantees unit operation in mix mode conditions.

It is possible a priority set on request of recovery hot water (priority DHW). The hot water unit production request can be performed by a proper potential-free contact.

Considerations on the installation

Desuperheater mode

The standard unit control at part load changes the water flow-rate, hot side, maintaining the supply temperature at the target value. Through the flow modulation the standard unit can produce hot water even over the set-point, up to a settable limit temperature (default 65°C). Thanks to this setting the exchanger operation time, hot user side, is extended in desuperheater mode, improving the unit efficiency of 5% compared to the desuperheater mode not active.



The logic of control above described drives to a proper design of hydraulic components and safety devices, considering the upper limit of hot water. It is possible to decrease this temperature down to the set point, not having the energy efficiency benefits that desuperheater solution leads.

The energy dimensioning from recovery has to consider that:

- in middle seasons the recovery heat production can be exclusive dissipating the cooling capacity on the external thermal source;
- in winter, the recovery heat production is obtained taking heat from the system use.

System water volume

For a proper operation of MULTIFUNCTION 2T unit is necessary to contemplate a correct design of water tanks both on user side and recovery side. Minimum system water volumes are described within 'General technical data' section and they have to be satisfied to avoid continuous compressor switching on and off. We recommend to increase minimum water volumes described to reduce compressor switching on and off in an hour and to limit drifting of water temperature during defrosting cycles.

Operation with water low temperatures on the exchanger, recovery side

When the hot water production function is enabled to the recovery but the water temperature is too low, the water produced to the recovery will have a temperature higher than the minimum level indicated in the graph. If this unit operating requirement is not acceptable, it is recommended to provide on the recovery side a primary - secondary where the secondary is maintained at the desired operating temperature while the primary will have a consistent operating temperatures within the limits shown in the graph

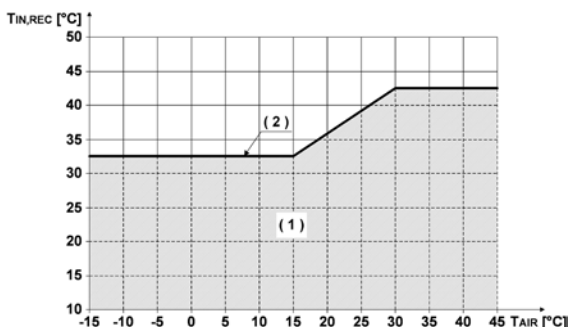

TIN,REC [°C] = Entering water temperature to recovery
TAIR [°C] = Entering external exchanger air temperature (D.B.)

1. Transient operating range where unit operates forcing on the recovery set-point (if the recovery function is enabled)
2. Minimum system water temperature level, recovery side

Recovery side water flow-rate

When pumps are not built-in it is necessary to contemplate recovery side water flow-rate modulation, managed by the unit with a 0-10V signal.

2-pipes unit operating range

The unit is capable of producing chilled water or domestic hot water on the user side. The total recovery heat exchanger allows for free domestic hot water production in summer operation mode and for the simultaneous production of chilled water and domestic hot water in winter operation mode.

Example of how the unit operates

System cooling only:

In this condition all the cooling capacity is released to the user side of the heat exchanger and maintenance of the user side set point is ensured through the modulation of the capacity steps. All the heating capacity is dispersed on the finned coil exchanger.

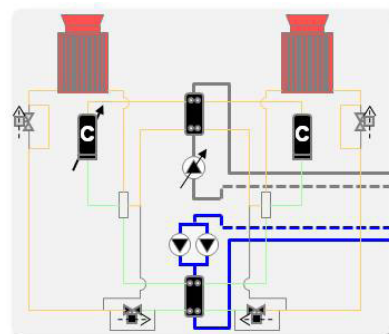

System heating only:

In this condition all the heating capacity is released to the user side of the heat exchanger and maintenance of the user side set point is ensured through the modulation of the capacity steps. All the cooling capacity is dispersed on the finned coil exchanger.

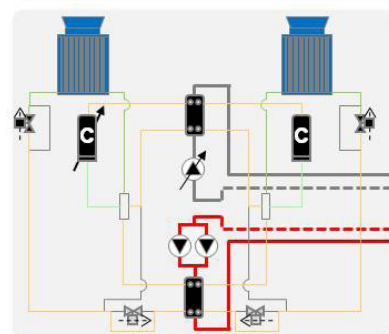

System cooling requirements and free production of domestic hot water:

In this condition, all the cooling capacity is released to the user side of the heat exchanger while all the heating capacity is released to the recovery side of the heat exchanger.

Maintenance of the user side set point is ensured through the modulation of the capacity steps. In this condition, the overall efficiency of the unit, defined as (chiller power for cold operation + heating capacity for recovery)/(total power input) is very high.

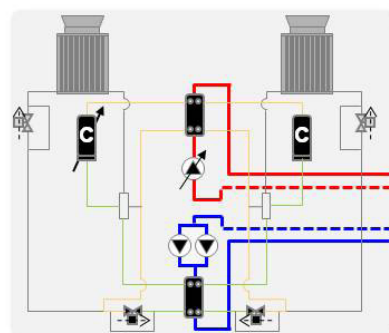

System heating requirements and production of domestic hot water:

In this condition, the heat is released at the same time to the user side and the recovery side of the heat exchanger.

The total heating capacity that can be provided to the two points of use cannot exceed 100% of the unit's nominal heating capacity. The unit will manage the capacity steps considering both loads, and through modulation of the flow it will initially serve the primary point of use, reserving the residual capacity for the secondary point of use. All the cooling capacity is dispersed on the finned coil exchanger.

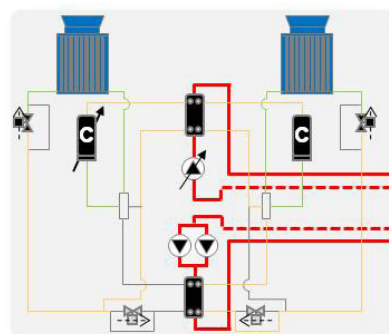

Requirement for the production of domestic hot water only:

In this condition all the heating capacity is released to the recovery side of the heat exchanger and the load requirements are met through the modulation of the capacity steps. All the cooling capacity is dispersed on the finned coil exchanger.

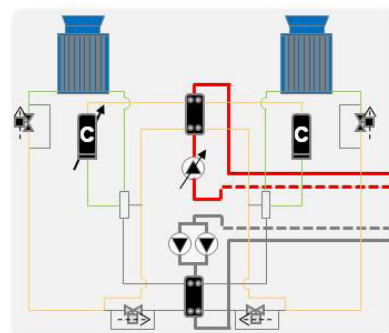

Configuration for 2-pipe system

Unit configuration

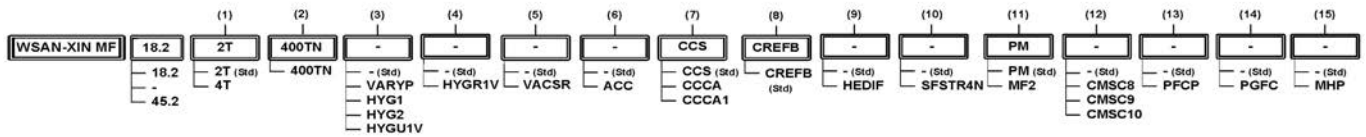

(1) Functionalities

2T - Unit for reversible 2-pipe system (standard)
4T - Unit for four-pipe systems

(2) Supply voltage

Supply voltage 400/3/50 + N (standard)

(3) User side hydronic assemblies

Refer to the diagrams of the hydronic assembly reported

(4) Recovery side hydronic assemblies

Refer to the diagrams of the hydronic assembly reported

(5) Recovery side DHW switching valve

Refer to the diagrams of the hydronic assembly reported

(6) Storage tank

(-) not required (standard)
ACC - Storage tank (only for size 35.2 - 45.2)

(7) Condenser coil

CCS - Standard condenser coil (standard)
CCA - Copper / aluminium condenser coil with acrylic lining
CCA1 - Condenser coil with Aluminum Energy Guard DCC treatment

(8) Type of fans

CREFB - ECOBREEZE external section fans consumption reduction device (Standard)

(9) Diffuser for fan

(-) not required (standard)
HEDIF - Diffuser for high efficiency axial fan

(10) Soft starter

(-) not required (standard)
SFSTR4N - Disposal for inrush current reduction

(11) Phase monitor

PM - Phase monitor (standard)
MF2 - Multi-function phase monitor

(12) Serial communication module

(-) not required standard
CMSC8 - Serial communication module for BACnet supervisor
CMSC9 - Serial communication module for Modbus supervisor
CMSC10 - Serial communication module for LonWorks supervisor

(13) Power capacitors

(-) not required (standard)
PFCP - Power factor correction capacitors (cosfi > 0.9)

(14) Protection grill

(-) not required (standard)
PGFC - Finned coil protection grill

(15) High and low pressure gauges

(-) not required (standard)
MHP - High and low pressure gauges

Functionalities	Hydronic assemblies				
2 PIPE INSTALLATION + TOTAL RECOVERY USER SIDE	Standard unit (STD)	Unit with VARYFLOW + (VARYP)	Unit with one ON/OFF pump (HYG1)	Unit with two ON/OFF pumps (HYG2)	Unit with one INVERTER pump (HYGU1V)
2 PIPE INSTALLATION + TOTAL RECOVERY RECOVERY SIDE	Standard unit (STD)	Unit with one INVERTER pump (HYGR1V)	Unit with DHW switching valve (VACSR)	Unit with 1 INVERTER pump and DHW switching valve (HYGR1V + VACSR)	

The unit may be configured by choosing one of the four user side hydronic assembly combinations with one of the four recovery side combinations depending on system requirements.

Accessories separately supplied			
<ul style="list-style-type: none"> • RCTX - Remote control 	<ul style="list-style-type: none"> • BACX - BACnet serial communication module • CMMBX - Serial communication module to supervisor (Modbus) • CMLWX - LonWorks serial communication module 	<ul style="list-style-type: none"> • PGFCX - Finned coil protection grill • IFWX - Steel mesh strainer on water side 	<ul style="list-style-type: none"> • AVIBX - Anti-vibration mount support • MHPX - High and low pressure gauges

Configuration for 2-pipe system

General technical data - Performance

Size			18.2	20.2	25.2	30.2	35.2	40.2	45.2
Cooling 100% - Heating 0%									
Cooling capacity	1	kW	49,8	59,6	69,7	82,5	92,8	106	120
Compressor power input	1	kW	14,5	18,1	20,5	25,6	30,4	35,0	42,2
Total power input	2	kW	16,7	20,3	23,4	28,5	33,3	38,4	45,6
EER	1		2,98	2,94	2,98	2,90	2,79	2,76	2,63
Water flow-rate	1	l/s	2,34	2,85	3,33	3,94	4,43	5,06	5,73
User side exchanger pressure drop	1	kPa	15	21	14	20	16	21	19
Cooling capacity (EN14511:2013)	3	kW	49,6	59,3	69,5	82,2	92,5	106	120
Total power input (EN14511:2013)	3	kW	16,9	20,6	23,6	28,8	33,6	38,8	46,0
EER (EN14511:2013)	3		2,93	2,88	2,94	2,85	2,75	2,72	2,60
SEER	9		3,34	3,43	3,47	3,63	3,72	3,70	3,79
Cooling 0% - Heating 100%									
Heating capacity	4	kW	55,7	68,0	77,8	92,6	106	122	139
Compressor power input	4	kW	15,0	18,7	21,2	25,8	29,8	34,2	39,6
Total power input	2	kW	17,2	20,9	24,1	28,7	32,7	37,6	43,0
COP	4		3,24	3,25	3,23	3,23	3,24	3,24	3,23
Water flow-rate	4	l/s	2,66	3,25	3,72	4,42	5,06	5,83	6,64
User side exchanger pressure drops	4	kPa	19	27	18	24	21	27	26
Heating capacity (EN14511:2013)	5	kW	56,0	68,4	78,1	93,0	106	123	140
Total power input (EN14511:2013)	5	kW	17,5	21,3	24,4	29,0	33,1	38,2	43,6
COP (EN14511:2013)	5		3,20	3,21	3,20	3,21	3,21	3,21	3,20
ErP Space Heating Energy Class - AVERAGE Climate - W35	8		A+	A+	A+	A+	-	-	-
SCOP - AVERAGE Climate - W35	9		3,55	3,59	3,45	3,61	3,68	3,65	3,81
Cooling 100% - Heating 100%									
Cooling capacity	6	kW	49,9	59,8	69,7	82,9	95,9	109	128
Heating capacity	6	kW	64,7	77,7	90,4	107	125	141	167
Total power input	6	kW	14,8	17,9	20,7	24,5	28,7	32,7	38,3
Overall efficiency	7		7,73	7,69	7,72	7,76	7,69	7,66	7,71
Exchanger water flow rate utility side	6	l/s	2,38	2,86	3,33	3,96	4,58	5,20	6,13
User side exchanger pressure drops	6	kPa	15	21	14	20	17	22	22
Recovery side exchanger water flow-rate	6	l/s	3,09	3,71	4,32	5,14	5,95	6,76	7,96
Recovery side exchanger pressure drop	6	kPa	52	62	67	66	53	53	65

The Product is compliant with the Erp (Energy Related Products) European Directive. It includes the Commission delegated Regulation (EU) No 811/2013 (rate heat output ≤ 70 kW at specified reference conditions) and the Commission delegated Regulation (EU) No 813/2013 (rated heat output ≤ 400 kW at specified reference conditions).
 *Contains fluorinated greenhouse gases (GWP 2087,5)

1. Data referred to the following conditions: User side exchanger water = 12/7°C. Entering external exchanger air temperature 35°C
2. The Total Power Input value does not take into account the part related to the pumps and required to overcome the pressure drops for the circulation of the solution inside the exchangers
3. Data compliant to Standard EN 14511:2013 referred to the following conditions: User side exchanger water = 12/7 °C. Entering external exchanger air temperature 35°C
4. Data referred to the following conditions: User side Exchanger water temperature = 40/45 °C. Entering external exchanger air temperature = 7°C D.B./6°C W.B
5. Data compliant to Standard EN 14511:2013 referred to the following conditions: User side Exchanger water temperature = 40/45 °C.. Entering external exchanger air temperature = 7°C D.B./6°C W.B
6. Data referred to the following conditions: User side exchanger water = 12/7 °C. Recovery side exchanger water = 40/45 °C.
7. Global efficiency, calculated as (Cooling capacity + Heating capacity)/(Total power input).
8. Seasonal Space Heating Energy Efficiency Class according to Commission delegated Regulation (EU) No 811/2013. W = Water outlet temperature (°C)
9. Data calculated according to the EN 14825:2016 Regulation

Configuration for 2-pipe system

General technical data - Construction

Size			18.2	20.2	25.2	30.2	35.2	40.2	45.2
Compressor									
Type of compressors			SCROLL INVERTER + SCROLL ON/OFF						
Refrigerant			R-410A						
No. of compressors		No	2	2	2	2	2	2	2
Oil charge (C1)		l	3,0	3,3	3,3	3,6	3,6	6,7	6,7
Oil charge (C2)		l	3,3	3,3	3,3	3,6	3,6	3,6	6,7
Refrigeration circuits		No	2	2	2	2	2	2	2
Refrigerant charge (C1)	1	kg	11,0	11,0	11,0	14,5	14,5	17,5	17,5
Refrigerant charge (C2)	1	kg	11,0	11,0	11,0	14,5	14,5	17,5	21,0
User side exchanger									
Type of exchanger	2		PHE						
No. of exchangers		No	1	1	1	1	1	1	1
Water content		l	9,70	9,70	14,5	14,5	15,8	15,8	19,3
User side minimum system water content	4	l	360	424	503	587	673	762	863
Recovery side exchanger									
Type of exchanger	2	No	PHE						
No. of exchangers		l	2	2	2	2	2	2	2
Water content			9,40	9,90	10,4	11,7	14,4	16,4	18,5
Recovery side minimum system water content	4	l	410	488	573	673	780	890	1021
External Section Fans									
Type of fans	3		EC						
No. of fans		No	2	2	2	2	2	2	2
Standard airflow		l/s	10556	10556	13056	13056	13333	14167	14167
Installed unit power		kW	1,1	1,1	1,4	1,4	1,5	1,7	1,7
Connections									
Water fittings			2"	2"	2" 1/2	2" 1/2	2" 1/2	2" 1/2	2" 1/2
Water circuit									
Maximum water side pressure		kPa	1000	1000	1000	1000	1000	1000	1000
Safety valve calibration		kPa	600	600	600	600	600	600	600
Power supply									
Standard power supply			400/3/50+N	400/3/50+N	400/3/50+N	400/3/50+N	400/3/50+N	400/3/50+N	400/3/50+N

1. Indicative values for standard units with possible +/-10% variation. The actual data are indicated on the label of the unit.

2. PHE = Plate exchanger

3. EC = Axial-flow fan + EC

4. The minimum system water content calculated value does not consider the internal exchanger water content. With outdoor air low temperature applications or low medium requested loads, the minimum installation water volume is obtained doubling the indicated value.

Configuration for 2-pipe system

Electrical data

Supply voltage 400/3/50+N

Size		18.2	20.2	25.2	30.2	35.2	40.2	45.2
F.L.A. - Full load current at max admissible conditions								
F.L.A. - Compressor 1 (ON/OFF)	A	16,8	24,3	26,6	30,8	30,8	40,6	40,6
F.L.A. - Compressor 2 (INVERTER)	A	20,8	20,8	23,3	29,5	32,1	32,1	40,5
F.L.A. - Single External Fan	A	3,9	3,9	3,9	3,9	3,9	3,9	3,9
F.L.A. - Total	A	45,5	52,9	57,7	68,1	70,7	80,5	88,9
L.R.A. - Locked rotor amperes								
L.R.A. - Compressor 1 (ON/OFF)	A	98,0	147	158	197	197	215	215
L.R.A. - Compressor 2 (INVERTER)	A	20,8	20,8	23,3	29,5	32,1	32,1	40,5
F.L.I. - Full load power input at max admissible conditions								
F.L.I. - Compressor 1 (ON/OFF)	kW	9,70	14,6	16,5	18,5	18,5	24,8	24,8
F.L.I. - Compressor 2 (INVERTER)	kW	12,7	12,7	14,6	18,0	19,6	19,6	26,7
F.L.I. - Single External Fan	kW	2,56	2,56	2,56	2,56	2,56	2,56	2,56
F.L.I. - Total	kW	27,5	32,5	36,3	41,6	43,3	49,6	56,6
M.I.C. Maximum inrush current								
M.I.C. - Value	A	126,6	175,6	189,1	234,3	237,0	255,0	263,3
M.I.C. - With soft start accessory	A	77,6	102,1	110,1	135,8	138,4	147,4	155,8

Power supply: 400/3/50 Hz. Voltage variation: max. +/-10%

Voltage unbalance between phases: max 2 %

For non standard voltage please contact Clivet technical office

Units are in compliance with the european law CEI EN 60204 and CEI EN 60335.

Sound levels

Standard unit

Size	Sound power level (dB)								Sound pressure level dB(A)	Sound power level dB(A)
	Octave band (Hz)									
	63	125	250	500	1000	2000	4000	8000		
18.2	90	83	78	80	78	72	67	61	65	82
20.2	89	82	80	81	77	72	64	59	65	82
25.2	90	83	80	81	79	74	68	60	66	83
30.2	91	84	82	83	78	75	66	59	66	84
35.2	91	85	82	84	79	74	67	61	68	85
40.2	92	85	83	84	80	75	67	62	68	85
45.2	94	86	83	84	82	77	71	63	69	86

Sound levels refer to units with full load under nominal test conditions.

The sound pressure level refers to a distance of 1 meter from the outer surface of the unit operating in open field.

Noise levels are determined using the tensiometric method (UNI EN ISO 9614-2)

Data referred to the following conditions:

entering / leaving exchanger water temperature user side 12/7°C

entering / leaving exchanger water temperature source side 30/35°C

Unit with HEDIF - "Diffuser for high efficiency axial fan" option

Size	Sound pressure level	Sound power level
	dB(A)	dB(A)
18.2	63	80
20.2	63	80
25.2	64	81
30.2	64	82
35.2	66	83
40.2	66	83
45.2	67	84

Sound levels refer to units with full load under nominal test conditions.

The sound pressure level refers to a distance of 1m from the outer surface of the unit operating in an open field.

Noise levels are determined using the tensiometric method (UNI EN ISO 9614-2)

Data referred to the following conditions:

internal exchanger water = 12/7°C

ambient temperature = 35 °C

Configuration for 2-pipe system

Operating range - Cooling

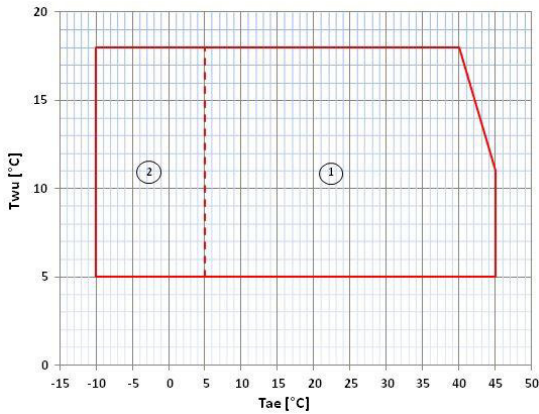

T_{wu} [°C] = Internal exchanger outlet water temperature
 T_{ae} [°C] = External exchanger inlet air temperature

1. Standard unit operating range at full load
2. Standard unit operating range with air flow automatic modulation

Operating range - Heating

User side

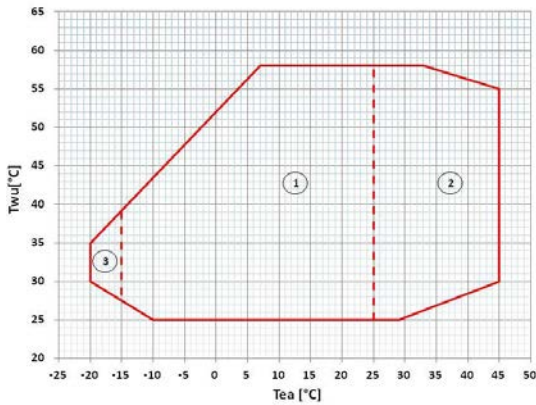

T_{wu} [°C] = Water outlet temperature from the user side of the heat exchanger
 T_{ae} [°C] = External exchanger inlet air temperature

1. Standard unit operating range at full load
2. Standard unit operating range with air flow automatic modulation
3. Unit operating range with automatic staging of the compressor capacity not compatible with Clivet integrated pumping unit (HYG1 - HYG2 - VARYP - HYGR1V)

Recovery side

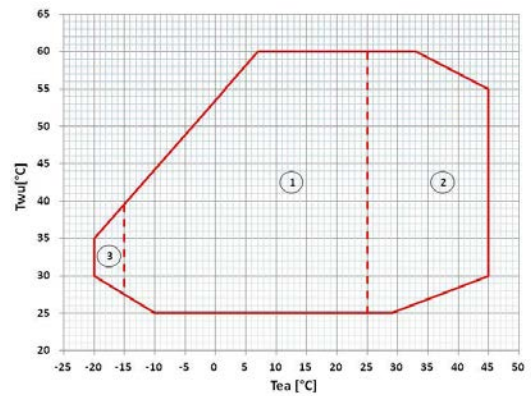

T_{wu} [°C] = Water outlet temperature at the recovery side of the heat exchanger
 T_{ae} [°C] = External exchanger inlet air temperature

1. Standard unit operating range at full load
2. Standard unit operating range with air flow automatic modulation
3. Unit operating range with automatic staging of the compressor capacity not compatible with Clivet integrated pumping unit (HYG1 - HYG2 - VARYP - HYGR1V)

Operating range - Cooling 100% - Heating 100%

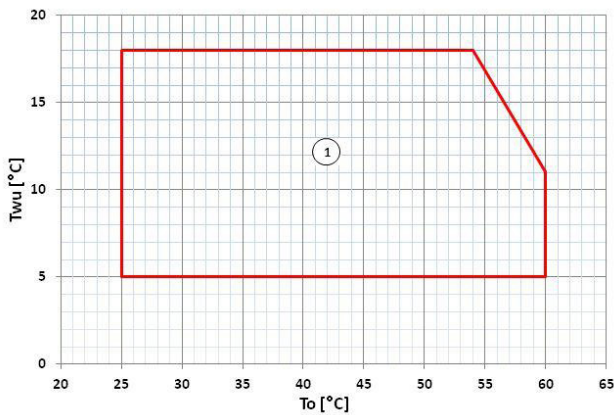

T_{wu} [°C] = Water outlet temperature from the user side of the heat exchanger (2-4 pipes)
 T_o [°C] = Outlet water temperature at the heat exchanger recovery side (2-4 pipes)

1. Standard unit operating range

Configuration for 2-pipe system

Performances in cooling

Size	To (°C)	Entering external exchanger air temperature (°C)											
		20		25		30		35		40		45	
		kWf	kWe	kWf	kWe	kWf	kWe	kWf	kWe	kWf	kWe	kWf	kWe
18.2	5	52,6	10,9	50,5	12,0	48,3	13,1	46,4	14,3	42,1	15,8	38,1	17,7
	7	56,3	11,1	54,1	12,2	51,8	13,3	49,8	14,5	45,0	16,1	40,8	18,0
	10	62,1	11,4	59,8	12,5	56,9	13,6	54,7	14,9	49,5	16,4	44,9	18,3
	12	65,8	11,7	63,2	12,7	60,2	13,8	57,7	15,1	52,1	16,6	-	-
	15	71,6	12,0	68,9	13,0	65,4	14,2	62,7	15,4	56,7	16,9	-	-
	18	77,7	12,3	74,6	13,4	70,8	14,5	67,7	15,8	61,3	17,3	-	-
20.2	5	63,2	13,6	60,9	14,9	58,0	16,3	55,5	17,8	50,4	19,6	45,8	22,0
	7	67,4	13,9	64,9	15,2	62,0	16,6	59,6	18,1	53,9	20,0	49,0	22,4
	10	74,4	14,3	71,5	15,6	68,1	17,0	65,3	18,6	59,1	20,4	54,2	22,7
	12	78,9	14,6	75,5	15,9	71,8	17,4	68,6	18,9	62,0	20,7	-	-
	15	85,6	15,0	82,0	16,3	77,6	17,8	74,2	19,4	67,4	21,2	-	-
	18	92,6	15,5	88,8	16,8	84,0	18,3	80,1	19,8	72,4	21,8	-	-
25.2	5	75,3	15,5	72,5	16,9	69,1	18,5	65,6	20,3	59,8	22,3	54,1	25,1
	7	80,3	15,8	77,0	17,2	73,3	18,8	69,7	20,5	63,5	22,6	57,4	25,3
	10	88,0	16,3	84,3	17,6	80,5	19,2	76,1	21,0	69,4	23,0	63,3	25,7
	12	92,9	16,6	89,2	18,0	84,8	19,6	80,3	21,3	73,3	23,3	-	-
	15	101	17,1	97,2	18,5	92,0	20,1	86,7	21,9	79,2	23,9	-	-
	18	109	17,7	104	19,1	98,9	20,6	93,0	22,3	85,1	24,4	-	-
30.2	5	89,2	19,7	86,5	21,4	82,2	23,1	77,6	25,2	71,0	27,7	64,4	30,9
	7	94,9	20,1	91,8	21,8	87,2	23,6	82,5	25,6	75,2	28,1	68,5	31,2
	10	104	20,8	100	22,5	95,0	24,4	89,5	26,4	81,5	28,9	75,3	32,0
	12	110	21,3	106	23,0	100	24,8	94,0	26,9	86,3	29,2	-	-
	15	119	22,0	115	23,6	108	25,5	102	27,6	93,1	30,3	-	-
	18	128	22,8	123	24,4	116	26,2	109	28,4	99,9	31,0	-	-
35.2	5	102	23,6	99,1	25,5	93,6	27,5	88,1	29,9	80,4	32,8	73,7	36,4
	7	109	24,1	105	26,0	98,7	28,1	92,8	30,4	84,6	33,3	78,2	36,8
	10	118	25,0	114	26,9	107	28,8	101	31,2	91,9	34,3	86,9	37,6
	12	126	25,5	121	27,5	114	29,5	107	31,9	98,0	34,8	-	-
	15	137	26,5	132	28,5	123	30,4	116	32,8	106	36,0	-	-
	18	146	27,3	139	29,3	131	31,3	123	33,6	114	36,6	-	-
40.2	5	118	26,6	114	28,9	108	31,4	101	34,3	92,1	37,8	84,3	41,8
	7	125	27,2	121	29,4	114	32,0	106	35,0	97,3	38,2	89,7	42,3
	10	136	28,1	131	30,3	124	32,9	116	35,7	106	39,1	98,8	43,2
	12	144	28,6	138	31,0	130	33,4	122	36,4	111	39,7	-	-
	15	156	29,6	150	31,9	141	34,4	131	37,3	120	40,9	-	-
	18	168	30,6	161	32,9	151	35,5	141	38,4	130	41,8	-	-
45.2	5	135	31,8	130	34,8	122	37,9	114	41,6	104	45,8	95,0	51,3
	7	142	32,5	136	35,5	128	38,7	120	42,2	109	46,6	100	51,8
	10	154	33,6	148	36,6	139	39,7	129	43,3	119	47,7	109	52,5
	12	162	34,3	155	37,2	145	40,4	136	44,0	126	48,6	-	-
	15	175	35,5	167	38,4	156	41,7	146	45,4	138	49,7	-	-
	18	188	36,9	179	39,8	167	42,8	157	46,5	145	51,8	-	-

kWf = Cooling capacity at the heat exchanger user side (2 pipes) or cold side (4 pipes) (kW)
 kWe = Electrical power absorbed by compressors (kW)
 To (°C) = outlet water temperature at the heat exchanger user side (2 pipes) or cold side (4 pipes) (°C)
 Performances in function of the inlet/outlet water temperature differential = 5°C

Configuration for 2-pipe system

Performance in Heating

Size	Tae (°C) D.B./W.B	Internal exchanger water outlet temperature (°C)									
		25		35		45		55		60	
		kWt	kWe	kWt	kWe	kWt	kWe	kWt	kWe	kWt	kWe
18.2	-15 / -15.4	30,4	9,45	30,7	11,4	-	-	-	-	-	-
	-10 / -10.5	36,1	9,65	36,4	11,6	-	-	-	-	-	-
	-7 / -8	39,4	9,77	39,7	11,7	39,1	14,2	-	-	-	-
	0 / -0.6	48,6	10,1	48,6	12,1	47,0	14,6	-	-	-	-
	7 / 6	58,5	10,4	58,1	12,5	55,7	15,0	51,9	18,6	49,6	19,6
	15 / 13	71,5	10,8	70,5	12,9	67,1	15,4	62,0	19,0	59,3	20,0
	20 / 16	78,1	11,0	76,9	13,1	72,5	15,6	66,8	19,2	64,1	20,2
20.2	-15 / -15.4	38,2	11,8	38,9	14,3	-	-	-	-	-	-
	-10 / -10.5	45,1	12,1	45,4	14,5	-	-	-	-	-	-
	-7 / -8	49,0	12,2	49,2	14,7	48,2	17,8	-	-	-	-
	0 / -0.6	60,1	12,5	59,9	15,1	57,9	18,3	-	-	-	-
	7 / 6	72,0	12,9	71,0	15,5	68,0	18,7	64,2	23,2	60,8	24,5
	15 / 13	87,4	13,4	86,0	16,0	81,8	19,2	76,5	23,7	72,3	24,9
	20 / 16	95,2	13,6	93,3	16,2	88,2	19,4	82,1	23,9	78,1	25,1
25.2	-15 / -15.4	43,6	13,5	43,8	16,3	-	-	-	-	-	-
	-10 / -10.5	51,5	13,7	51,3	16,6	-	-	-	-	-	-
	-7 / -8	56,0	13,9	55,7	16,7	55,0	20,4	-	-	-	-
	0 / -0.6	69,2	14,2	68,0	17,2	66,1	20,8	-	-	-	-
	7 / 6	82,7	14,7	80,9	17,6	77,8	21,2	72,7	26,4	69,1	27,8
	15 / 13	101	15,3	98,1	18,2	93,1	21,7	86,0	26,7	82,2	28,2
	20 / 16	110	15,6	106	18,4	101	21,9	92,8	26,9	88,1	28,4
30.2	-15 / -15.4	52,1	16,2	52,9	19,6	-	-	-	-	-	-
	-10 / -10.5	61,3	16,6	61,7	20,0	-	-	-	-	-	-
	-7 / -8	66,4	16,8	66,5	20,3	65,8	24,5	-	-	-	-
	0 / -0.6	81,8	17,4	81,1	21,0	79,0	25,2	-	-	-	-
	7 / 6	98,2	18,1	96,3	21,6	92,6	25,8	86,4	31,7	83,2	33,5
	15 / 13	119	18,9	116	22,4	111	26,5	102	32,4	97,8	34,2
	20 / 16	130	19,3	126	22,8	120	26,9	111	32,8	106	34,6
35.2	-15 / -15.4	59,8	16,9	61,0	23,2	-	-	-	-	-	-
	-10 / -10.5	70,5	17,4	70,6	23,6	-	-	-	-	-	-
	-7 / -8	76,3	17,7	76,1	23,8	75,2	28,7	-	-	-	-
	0 / -0.6	94,3	18,5	92,6	24,4	90,0	29,2	-	-	-	-
	7 / 6	113	19,4	110	25,1	106	29,8	98,7	36,3	88,8	39,6
	15 / 13	138	20,5	133	26,0	126	30,6	116	37,0	106	40,2
	20 / 16	150	21,1	144	26,4	137	30,9	125	37,3	114	40,6
40.2	-15 / -15.4	69,1	23,0	70,1	26,2	-	-	-	-	-	-
	-10 / -10.5	80,7	23,3	81,5	26,6	-	-	-	-	-	-
	-7 / -8	87,6	23,5	87,9	26,9	87,0	33,0	-	-	-	-
	0 / -0.6	108	24,1	107	27,5	104	33,6	-	-	-	-
	7 / 6	129	24,8	127	28,2	122	34,2	114	42,0	105	44,3
	15 / 13	156	25,7	153	29,1	146	35,0	135	42,5	122	44,9
	20 / 16	170	26,2	167	29,6	158	35,4	146	43,1	130	45,3
45.2	-15 / -15.4	77,8	24,1	79,7	30,0	-	-	-	-	-	-
	-10 / -10.5	91,1	24,7	92,5	30,6	-	-	-	-	-	-
	-7 / -8	98,5	25,0	99,5	30,9	99,5	37,9	-	-	-	-
	0 / -0.6	121	25,9	121	31,9	119	38,8	-	-	-	-
	7 / 6	144	26,8	143	32,7	139	39,6	131	48,7	125	51,3
	15 / 13	175	27,9	172	33,7	165	40,5	153	49,3	146	51,9
	20 / 16	190	28,5	186	34,2	178	40,9	165	49,8	158	52,4

kWt = Heating capacity to the hot side exchanger (kW)

kWe = Electrical power absorbed by compressors (kW)

Tae [°C]: External exchanger inlet air temperature

Performances in function of the inlet/outlet water temperature differential = 5°C

Admissible water flow-rates

Minimum (Qmin) and maximum (Qmax) admissible water flow for the unit to operate correctly.

User side exchanger (2/4 - pipes)

Size		18.2	20.2	25.2	30.2	35.2	40.2	45.2
Qmin	[l/s]	1,9	1,9	2,7	2,7	3,3	3,3	3,9
Qmax	[l/s]	6,5	6,5	9,3	9,3	11,5	11,5	13,6

Recovery exchanger (2/4 - pipes)

Size		18.2	20.2	25.2	30.2	35.2	40.2	45.2
Qmin	[l/s]	1,2	1,3	2,0	2,0	3,0	3,0	3,0
Qmax	[l/s]	4,2	4,2	6,5	6,5	9,0	9,5	10,0

Correction factors for glycol use

Internal exchanger (evaporator)

% ethylene glycol by weight		5%	10%	15%	20%	25%	30%	35%	40%
Freezing temperature	°C	-2,0	-3,9	-6,5	-8,9	-11,8	-15,6	-19,0	-23,4
Safety temperature	°C	3	1	-1	-4	-6	-10	-14	-19
Cooling Capacity Factor		0,995	0,990	0,985	0,981	0,977	0,974	0,971	0,968
Compressor power input Factor		0,997	0,993	0,990	0,988	0,986	0,984	0,982	0,981
Internal exchanger glycol solution flow factor		1,003	1,010	1,020	1,033	1,050	1,072	1,095	1,124
Pressure drop Factor		1,029	1,060	1,090	1,118	1,149	1,182	1,211	1,243

Fouling Correction Factors

m ² °C/W	Internal exchanger	
	F1	FK1
0,44 x 10 ⁻⁴	1,0	1,0
0,88 x 10 ⁻⁴	0,97	0,99
1,76 x 10 ⁻⁴	0,94	0,98

F1 = Cooling capacity correction factors

FK1 = Compressor power input correction factor

Overload and control device calibrations

		open	closed	Value
High pressure switch	[kPa]	4050	3300	-
Low pressure switch	[kPa]	450	600	-
Low pressure switch (Brine)	[kPa]	200	350	-
Antifreeze protection	[C]	-3	5,5	-
High pressure safety valve	[kPa]	-	-	4500
Low pressure safety valve	[kPa]	-	-	3000
Max no. of compressor starts per hour	[n°]	-	-	10
Max no. of compressor starts per hour	[n°]	-	-	-
Discharge safety thermostat	[C°]	-	-	120
Fusible plug High pressure safety	[C°]	-	-	-

Integrated heating capacities

Air temperature external exchanger inlet °C (B.S. / B.U)	-10/-10,5	-5/-5,4	0/0,6	5/3,9	Others
Heating capacity multiplication coefficient	0,90	0,89	0,88	0,91	1

User side (2/4 - pipes)

Configuration: Standard unit (STD)

Configuration without hydronic assembly, equipped with components as described on the water diagram key.
All water fittings are Victaulic type. It is possible to control an external pump by an on/off or 0-10V signal.

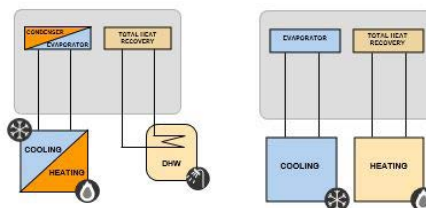

Exchanger pressure drop curves

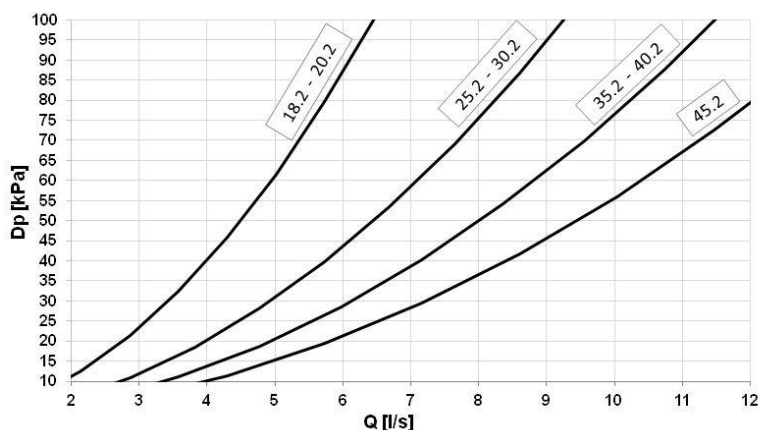

The pressure drops on the water side are calculated by considering an average water temperature at 7°C.

Q = Water flow rate [l/s]
DP = Pressure drops [kPa]

The water flow rate must be calculated with the following formula

$$Q \text{ [l/s]} = kWf / (4,186 \times DT)$$

kWf = Cooling capacity in kW
DT = Temperature difference between entering / leaving water

To the user side exchanger (2 pipe) and cold side (4 pipe) pressure drops must be added the pressure drops of the steel mesh mechanical strainer that must be placed on the water input line. It is a device compulsory for the correct unit operation, and it is available as accessory IFWX

Water diagram water side

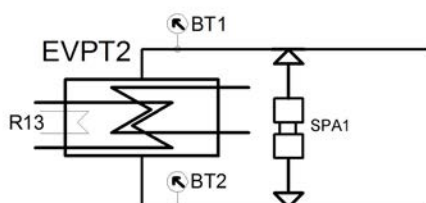

EVPT2 = Plate evaporator 2 circuits
R13 = Evaporator group heater
BT1 = Probes of entering water temperature
BT2 = Probes of leaving water temperature
SPA1 = Differential water pressure switch

User side (2/4 - pipes)

Configuration: Unit with VARYFLOW+ (VARYP)

Configuration with 2 centrifugal electric pumps arranged in parallel and controlled by inverter, with housing and impeller made with AISI 304 stainless steel, and components as described on the water diagram key. All water fittings are Victaulic type. The electric pumps are equipped with three-phase electric motor with IP55-protection and complete with thermoformed insulated casing.

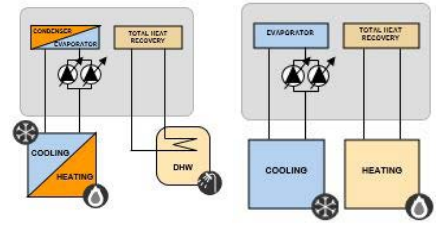

The control, modulates the water flow-rate keeping constant the delta T.

If the water temperature is in critical conditions, it allows to extend the unit operating ranges guaranteeing its operating, automatically reducing the water flow-rate. In the event of one of the two pumps is temporarily unavailable, it guarantees about the 80% of the nominal flow-rate.

VARYFLOW + pressure head (Size 18.2 - 30.2)

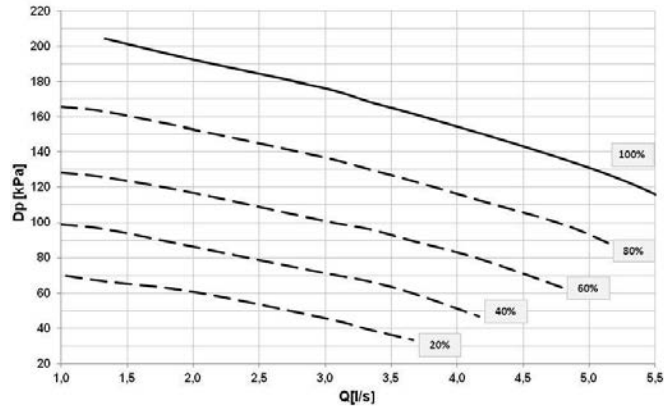

Q = Water flow rate [l/s]

DP = Pressure head [kPa]

Caution: to obtain the available pressure values, you need to subtract the following from the head values represented in these diagrams:



- User side exchanger pressure drops
- IFVX accessory steel mesh filter on the water side (where applicable)

VARYFLOW + pressure head + (Size 35.2 - 45.2)

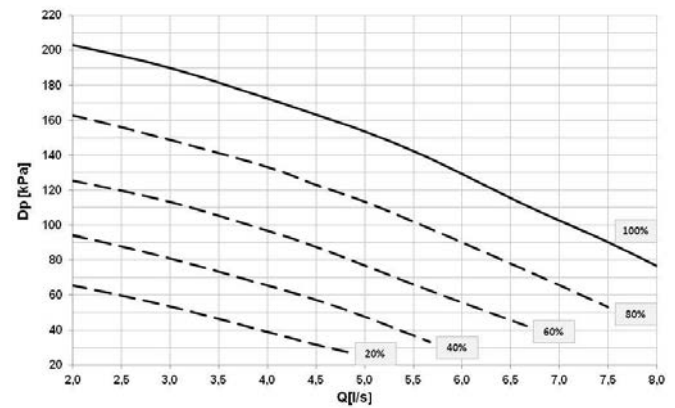

Q = Water flow rate [l/s]

DP = Pressure head [kPa]

WARYFLOW + absorption curves (Size 18.2 - 30.2)

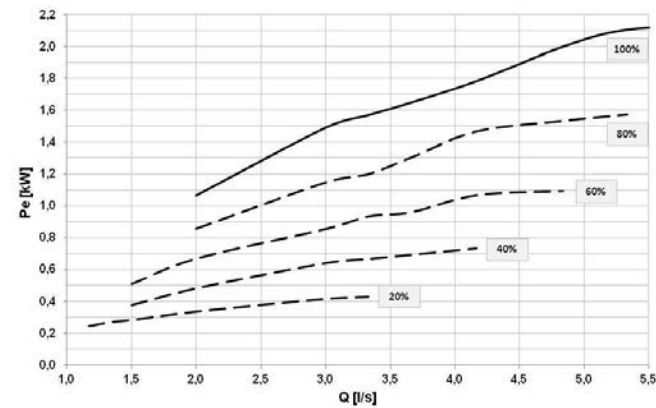

Q = Water flow rate [l/s]

Pe = Electric power consumption [kW]

WARYFLOW + absorption curves (Size 35.2 - 45.2)

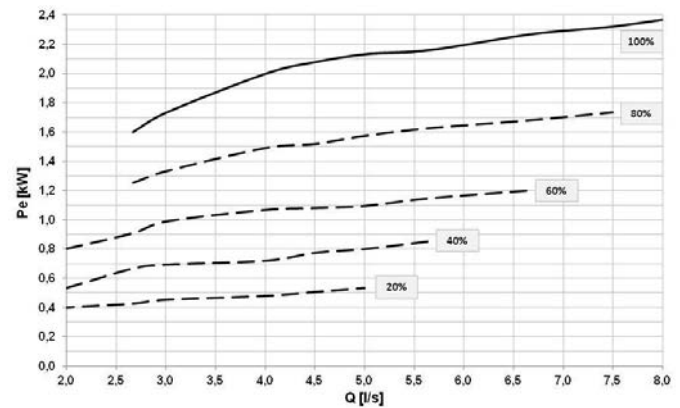

Q = Water flow rate [l/s]

Pe = Electric power consumption [kW]

Water diagram

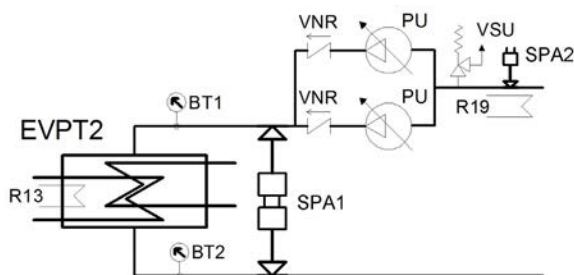

- EVPT2 = Plate evaporator 2 circuits
- R13 = Evaporator group heater
- BT1 = Probes of entering water temperature
- BT2 = Probes of leaving water temperature
- VNR = Non return valves
- SPA1 = Differential water pressure switch
- PU = Hydronic assembly VARYFLOW +
- VSU = Water safety valve
- R19 = Hydronic assembly heaters
- SPA2 = System water pressure switch

User side (2/4 - pipes) Configuration: Unit with 1 ON/OFF pump (HYG1)

Configuration with 1 centrifugal electric pump, with housing and impeller made with AISI 304 stainless steel, and components as described on the water diagram key. All water fittings are Victaulic type.

The electric pump is equipped with three-phase electric motor with IP55-protection and complete with thermoformed insulated casing.

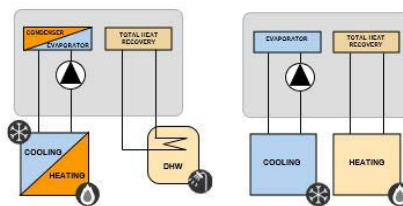

ON/OFF pump available pressure (Size 18.2 - 45.2)

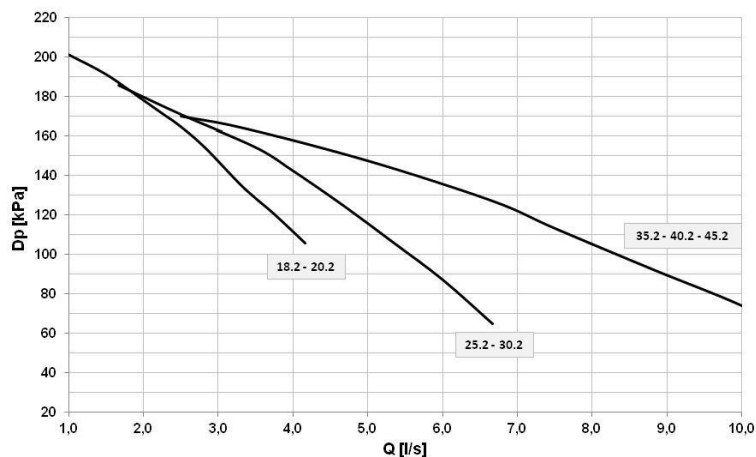

Q = Water flow rate [l/s]
DP = Pressure head [kPa]



Caution: to obtain the available pressure values, you need to subtract the following from the head values represented in these diagrams:

- User side exchanger pressure drops
- IFVX accessory steel mesh filter on the water side (where applicable)

ON/OFF pump absorption curves (Size 18.2 - 45.2)

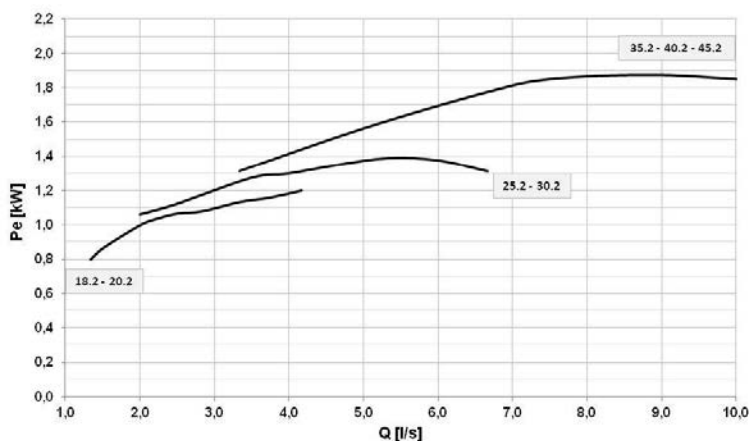

Q = Water flow rate [l/s]
Pe = Electric power consumption [kW]

Water diagram

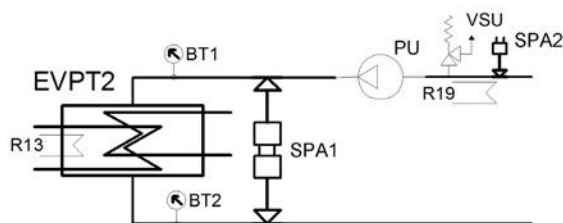

- EVPT2 = Plate evaporator 2 circuits
- R13 = Evaporator group heater
- BT1 = Probes of entering water temperature
- BT2 = Probes of leaving water temperature
- SPA1 = Differential water pressure switch
- PU = Hydronic assembly 1 ON/OFF pump
- VSU = Water safety valve
- R19 = Hydronic assembly heaters
- SPA2 = System water pressure switch

User side (2/4 - pipes) Configuration: Unit with 2 ON/OFF pumps (HYG2)

Configuration with 2 centrifugal electric pumps, 1 stand-by, with housing and impeller made with AISI 304 stainless steel, and components as described on the water diagram key. All water fittings are Victaulic type. The electric pumps are equipped with three-phase electric motor with IP55-protection and complete with thermoformed insulated casing.

The control balances the operating hours and in case of failure it is signaled and the stand-by pump is automatically activated.

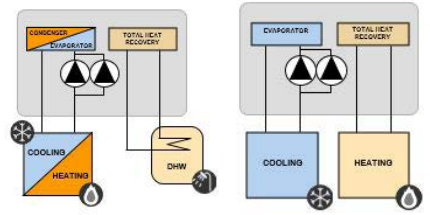

ON/OFF pump available pressure (Size 18.2 - 45.2)

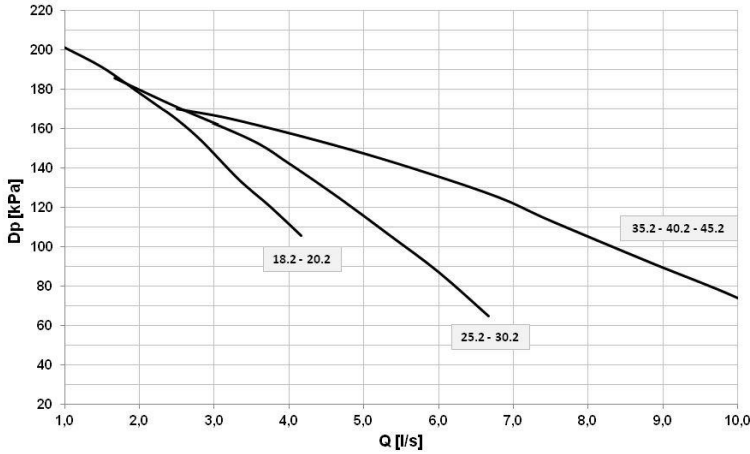

Q = Water flow rate [l/s]
DP = Pressure head [kPa]



Caution: to obtain the available pressure values, you need to subtract the following from the head values represented in these diagrams:

- User side exchanger pressure drops
- IFVX accessory steel mesh filter on the water side (where applicable)

ON/OFF pump absorption curves (Size 18.2 - 45.2)

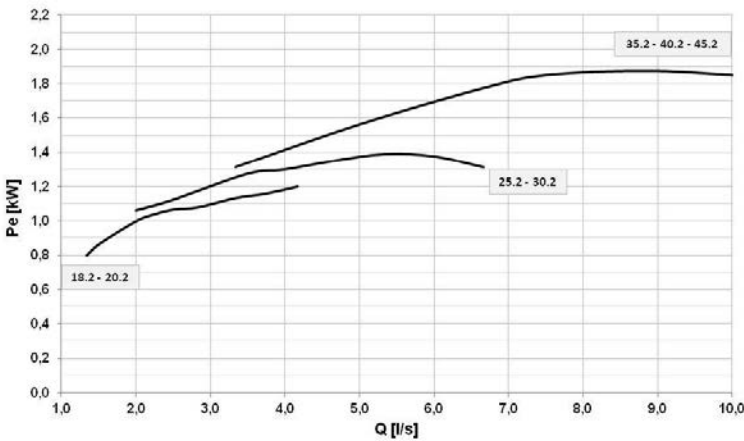

Q = Water flow rate [l/s]
Pe = Electric power consumption [kW]

Water diagram

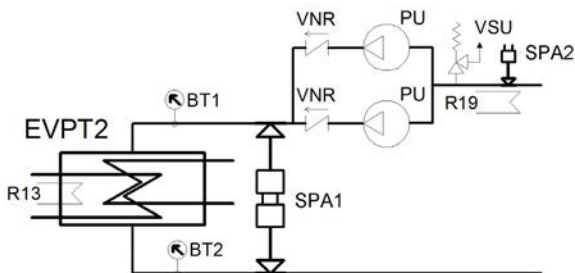

- EVPT2 = Plate evaporator 2 circuits
- R13 = Evaporator group heater
- BT1 = Probes of entering water temperature
- BT2 = Probes of leaving water temperature
- VNR = Non return valves
- SPA1 = Differential water pressure switch
- PU = Hydronic assembly 2 ON/OFF pumps
- VSU = Water safety valve
- R19 = Hydronic assembly heaters
- SPA2 = System water pressure switch

Recovery side (2/4 - pipes)

Configuration: Unit with 1 INVERTER pump (HYGU1V)

This configuration provides for one inverter-controlled electric centrifugal pump with body and impeller in AISI 304 steel and components listed in the key of the included water diagram. All water fittings are Victaulic. The electric pump is equipped with three-phase electric motor with IP55-protection and complete with thermoformed insulated casing.

Adjustment enables the optimised load distribution according to the system requirements.

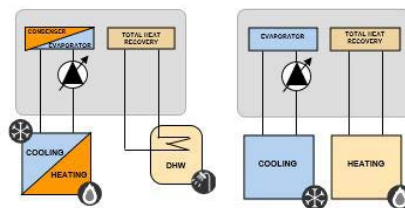

Inverter pump pressure head (Size 18.2 - 20.2)

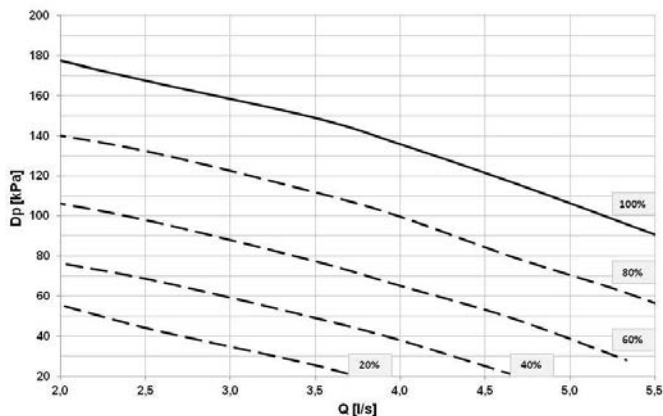

Q = Water flow rate [l/s]
DP = Pressure head [kPa]

Inverter pump pressure head (Size 25.2 - 30.2)

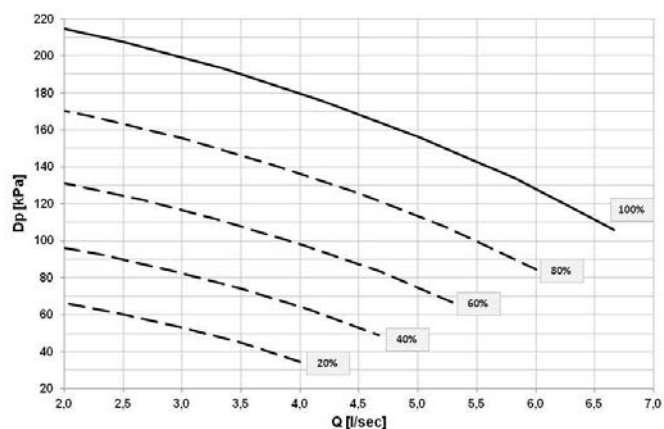

Q = Water flow rate [l/s]
DP = Pressure head [kPa]

Inverter pump absorption curve (Size 18.2 - 20.2)

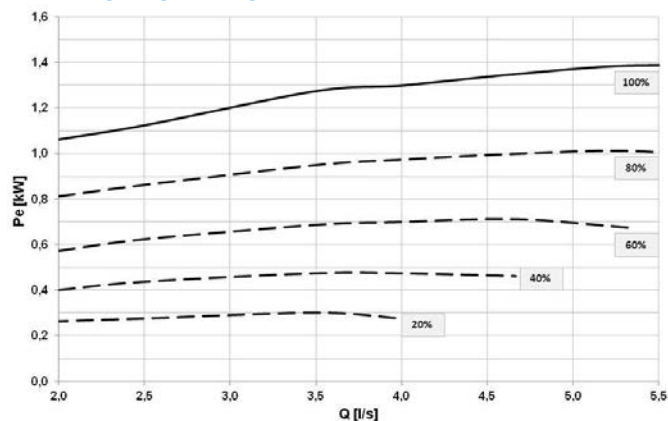

Q = Water flow rate [l/s]
Pe = Electric power consumption [kW]

Inverter pump absorption curve (Size 25.2 - 30.2)

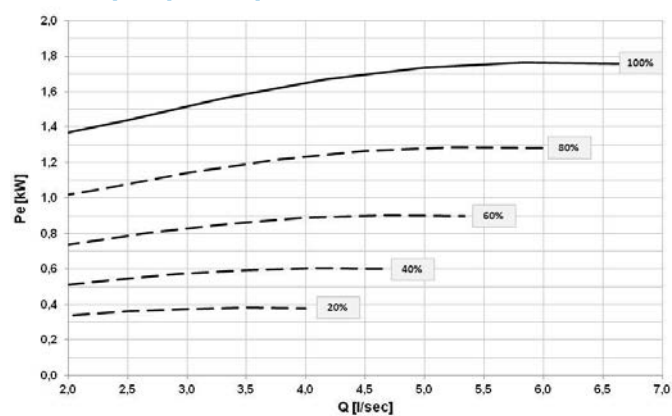

Q = Water flow rate [l/s]
Pe = Electric power consumption [kW]

Inverter pump available pressure (Size 35.2 - 45.2)

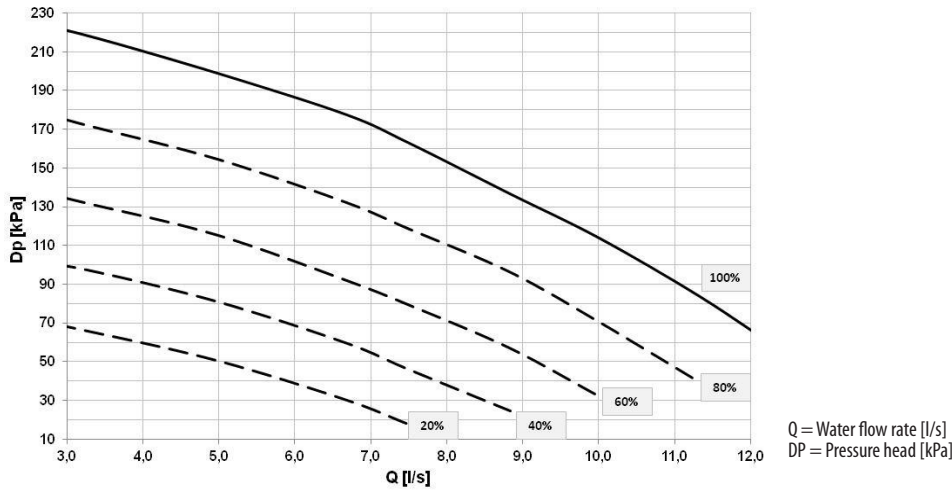

Caution: to obtain the available pressure values, you need to subtract the following from the head values represented in these diagrams:

- User side exchanger pressure drops
- IFVX accessory steel mesh filter on the water side (where applicable)

Inverter pump absorption curve (Size 35.2 - 45.2)

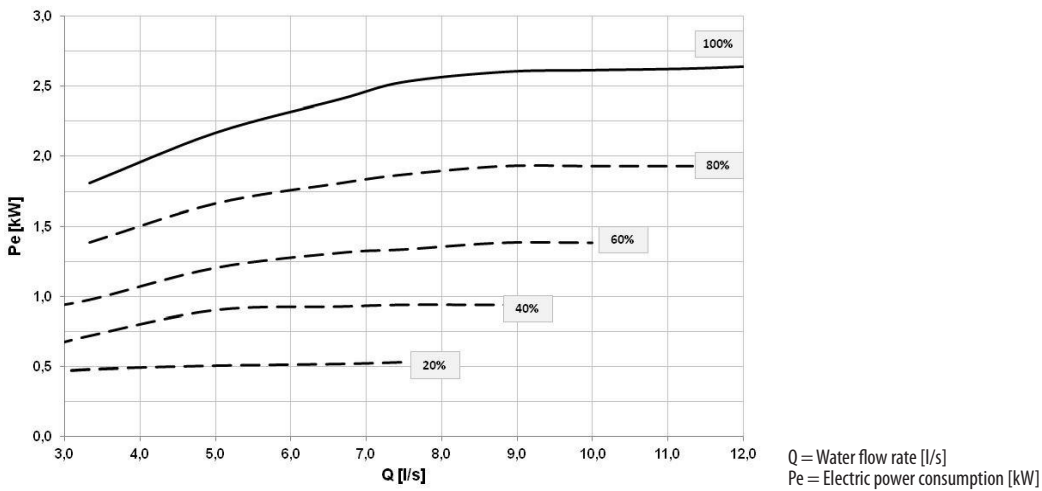

Water diagram

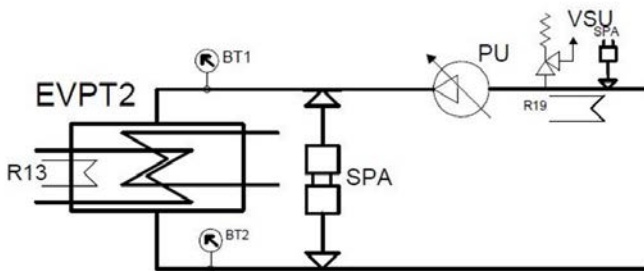

- EVPT2 = Plate evaporator 2 circuits
- R13 = Evaporator group heater
- BT1 = Probes of entering water temperature
- BT2 = Probes of leaving water temperature
- SPA1 = Differential water pressure switch
- PU = Hydronic assembly 1 INVERTER pump
- VSU = Water safety valve
- R19 = Hydronic assembly heaters
- SPA2 = System water pressure switch

Recovery side (2/4 - pipes) Configuration: Standard unit (STD)

Configuration without hydronic assembly, equipped with components as described on the water diagram key.

All water fittings are Victaulic type. It is possible to control an external pump by an on/off or 0-10V signal.

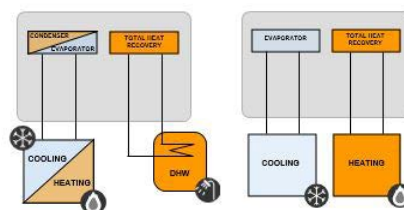

Exchanger pressure drop curves

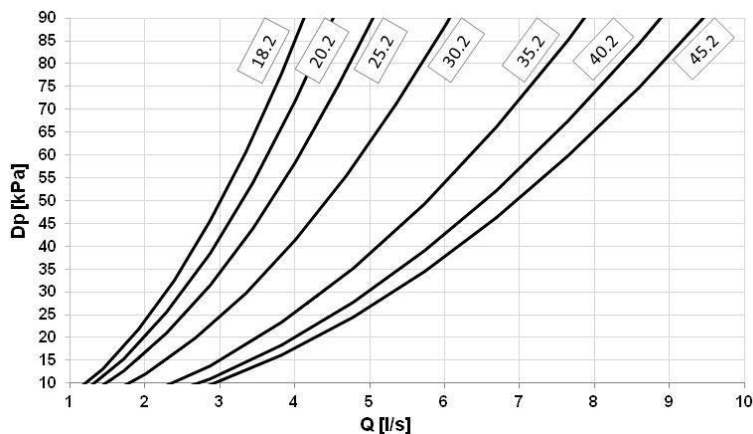

The pressure drops on the water side are calculated by considering an average water temperature at 7°C.

Q = Water flow rate [l/s]
DP = Pressure drops [kPa]

To the pressure drop at the heat exchanger recovery side (2 pipes) and hot side (4 pipes) we must also add the pressure drop at the steel mesh filter installed on the water intake line. This device is essential to the unit's proper operation, and is available as accessory IFWX.

Water diagram

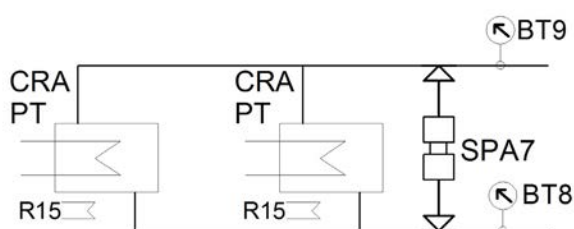

CRA PT = Water cooled plate condenser
R15 = Condenser unit heaters
BT9 = Water outlet temperature probes
SPA7 = Water differential pressure switch
BT8 = Water inlet temperature probes

Recovery side (2/4 - pipes)

Configuration: Unit with 1 inverter pump (HYGR1V)

This configuration provides for one inverter-controlled electric centrifugal pump with body and impeller in AISI 304 steel and components listed in the key of the included water diagram. All water fittings are Victaulic. The electric pump is equipped with three-phase electric motor with IP55-protection and complete with thermoformed insulated casing.

Adjustment enables the optimised load distribution according to the system requirements.

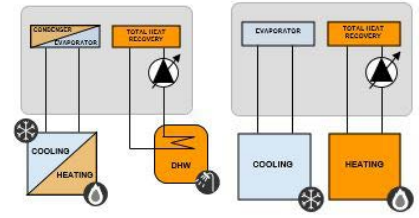

Inverter pump pressure head (Size 18.2 - 20.2)

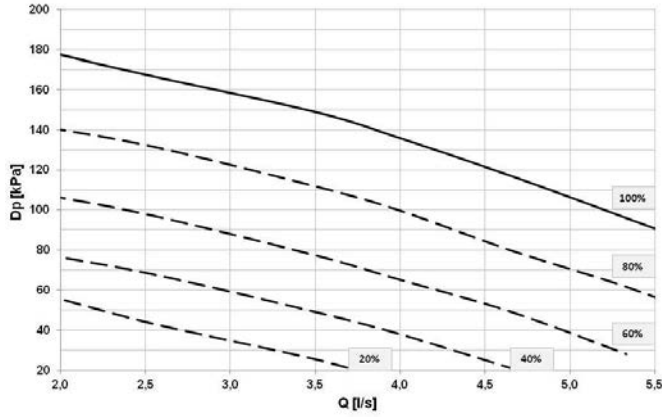

Q = Water flow rate [l/s]
DP = Pressure head [kPa]

Inverter pump pressure head (Size 25.2 - 30.2)

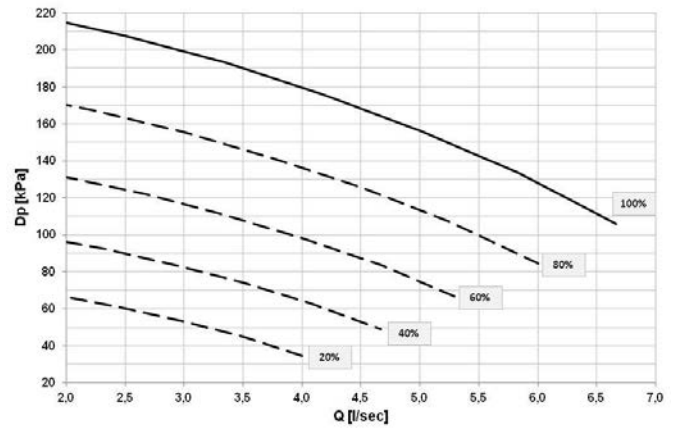

Q = Water flow rate [l/s]
DP = Pressure head [kPa]

Inverter pump absorption curve (Size 18.2 - 20.2)

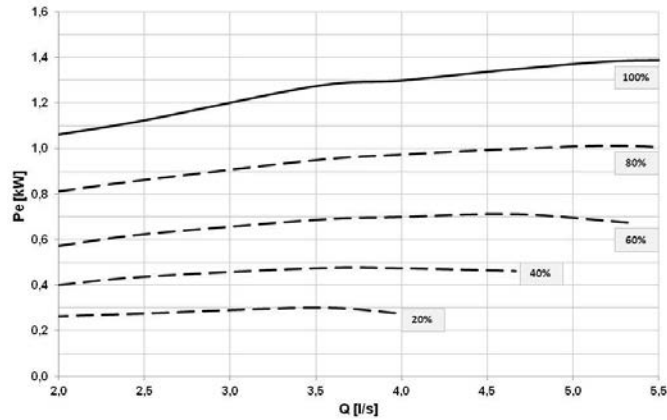

Q = Water flow rate [l/s]
Pe = Electric power consumption [kW]

Inverter pump absorption curve (Size 25.2 - 30.2)

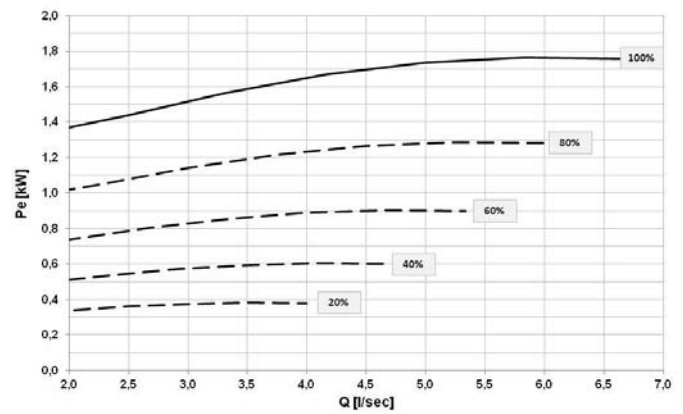

Q = Water flow rate [l/s]
Pe = Electric power consumption [kW]

Inverter pump available pressure (Size 35.2 - 45.2)

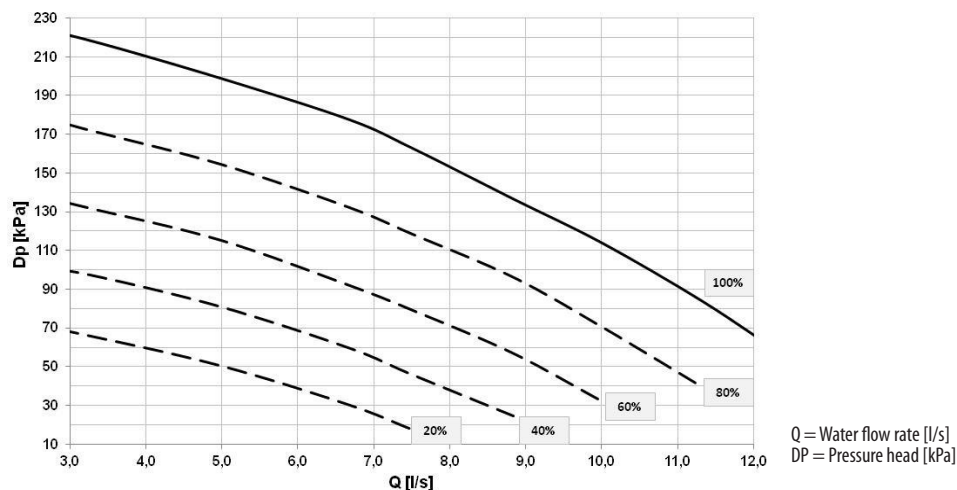

Caution: to obtain the available pressure values, you need to subtract the following from the head values represented in these diagrams:

- User side exchanger pressure drops
- IFVX accessory steel mesh filter on the water side (where applicable)

Inverter pump absorption curve (Size 35.2 - 45.2)

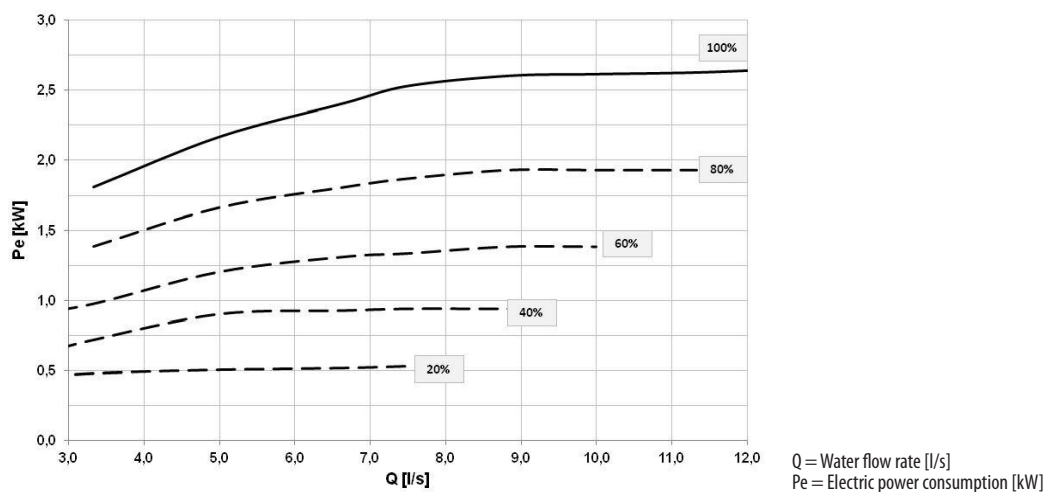

Water diagram

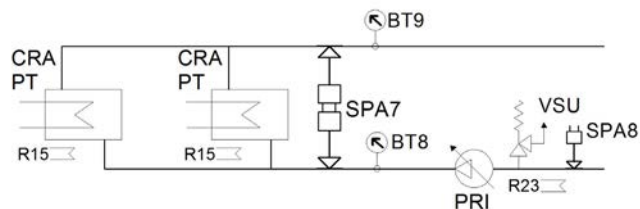

- CRA PT = Water cooled plate condenser
- R15 = Condenser unit heaters
- BT9 = Water outlet temperature probes
- SPA7 = Water differential pressure switch
- BT8 = Water inlet temperature probes
- PRI = Hydronic assembly 1 inverter pump
- VSU = Water safety valve
- R23 = Hydronic assembly heaters
- SPA8 = Circuit charging pressure switch

Recovery side (2/4 - pipes)

Configuration: Unit with DHW switching valve(VACSR)

Configuration with on/off 3-way valve for the water flow-rate diverting, and components as described on the water diagram key. All water fittings are Victaulic type.

The DHW call is triggered by the closure of a potential-free contact on the unit electrical panel. The control triggers the switching of the 3-way valve so that it deviates the flow, switching from the system set point to the DHW's set point, performing the temperature regulation and activating or deactivating the compressors based on the distance from the DHW set point.

The DHW switching valve (VACSR) can be matched to the hydronic assemblies recovery side indicated in the previous pages according to the diagrams below.

**VACSR
(2 - pipes)**

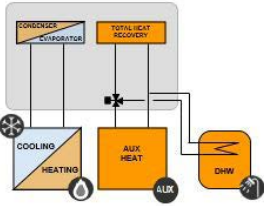

**VACSR
(4 - pipes)**

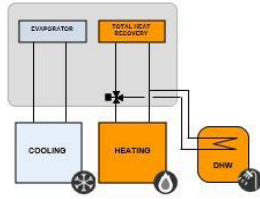

**HYGR1V+VACSR
(2 - pipes)**

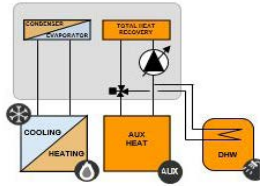

**HYGR1V+VACSR
(4 - pipes)**

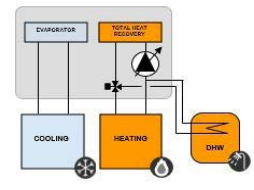

3-way valve pressure drop curves

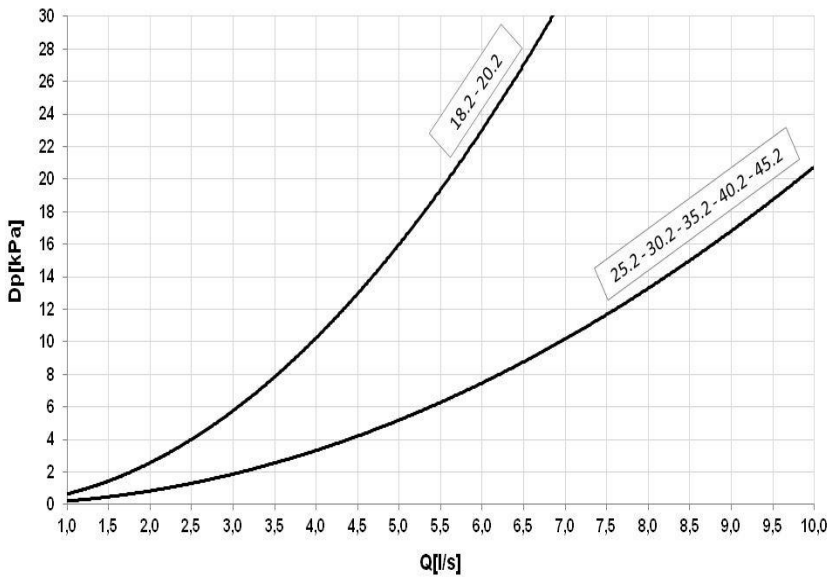

Q = Water flow rate [l/s]
DP = Pressure drops [kPa]

Water diagram

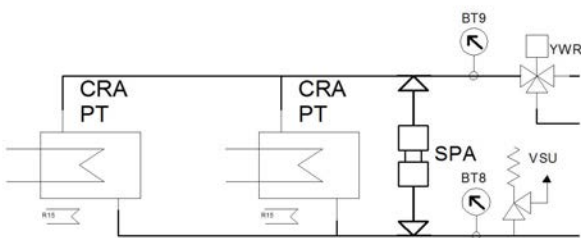

- CRA PT = Water cooled plate condenser
- R15 = Condenser unit heaters
- BT9 = Water outlet temperature probes
- SPA7 = Water differential pressure switch
- BT8 = Water inlet temperature probes
- YWR = DHW switching valve
- VSU = Water safety valve

Built-in configuration options

ACC - Storage tank

Option supplied built-in the unit. Steel storage tank complete with double layer covering with closed-cell insulation, stainless steel anti-freeze immersion resistance, bleed valve, draw off cock, cast-iron shut-off butterfly valve with quick connections and activation lever with a mechanical calibration lock at the evaporator output, quick connections with insulated casing.

Available only for size 35.2 - 45.2.

The storage tank capacity is 150L.

CCCA - Copper / aluminium condenser coil with acrylic lining

Coils with copper pipes and aluminium fins with acrylic lining. Resist bi-metallic corrosion and allow for application in coastal areas.

Attention!

- Cooling capacity variation -2.7%
- variation in compressor power input +4.2%
- operating range reduction -2.1°C

CCCA1 - Condenser coil with Aluminium Energy Guard DCC treatment

A treatment which offers an optimal thermal exchange and guarantees and protects the finned coil exchangers from corrosion over time. Can be used in settings with very aggressive saline concentrations and other chemical agents in the air thus maintaining the performance of the coils over time.

PFCP - Power factor correction capacitors (cosφ > 0.9)

The component is necessary to lower the phase difference between current and voltage in the electromagnetic components of the unit (e.g. asynchronous motors). The component allows to put the cosφ power factor to values on average higher than 0.9, reducing the network reactive power. This often leads to an economic benefit which the energy provider grants to the final user.

MF2 - Multi-function phase monitor

Multifunction phase monitor supplied as standard: it controls the presence and the correct phase sequences, verifies possible voltage anomalies (-10%), it automatically resets the unit operation, when the correct power supply is re-established

This control allows to:

- protect the internal components of the unit, which are powered by an abnormal voltage, may operate incorrectly or break;
- quickly identify, among the alarms of the unit's components, the real cause of the malfunction due to the sudden change in voltage.

SFSTR4N - Disposal for inrush current reduction, for unit 400/3/50+N

Electronic device that automatically and gradually starts the compressors, thereby reducing the current peak generated in star-triangle start-ups and therefore reduces the mechanical stress on the motor and the electrodynamic stress on the power cables and on the mains.

PGFC – Finned coil protection grill

This accessory is used to protect the external coil from the accidental contact with external things or people.

Ideal for installation in places where persons can pass from, such as car parks, terraces, etc.

HEDIF - Diffuser for high efficiency axial fan

The new AxiTop diffuser creates an ideal air distribution: it aerodynamically decelerates the flow and transforms a big part of its kinetic energy in static pressure, obtaining:

- down to -3 dB of silence
- reduction of 3% of the absorbed energy

Since the fans are the unit's main noise source, the benefits are evident especially during the night hours, when the load is reduced but sensitivity to noise is enhanced.

CMSC8 - Serial communication module for BACnet supervisor

This enables the serial connection of the supervision system, using BACnet as the communication protocol. It enables access to the complete list of operational variables, commands and alarms. Using this accessory every unit can dialogue with the main supervision systems.



The configuration and management activities for the BACnet networks are the responsibility of the client.



The total length of each serial line do not exceed 1000 meters and the line must be connected in bus typology (in/out)

CMSC9 - Serial communication module for Modbus supervisor

This enables the serial connection of the supervision system, using Modbus as the communication protocol. It enables access to the complete list of operational variables, commands and alarms. Using this accessory every unit can dialogue with the main supervision systems.

The device is installed and wired built-in the unit.



The total length of each serial line do not exceed 1000 meters and the line must be connected in bus typology (in/out)

CMSC10 - Serial communication module for LonWorks supervisor

This enables the serial connection of the supervision system which uses the LonWorks communication protocol. It enables access to a list of operating variables, commands and alarms which comply with the Echelon® standard.

The device is installed and wired built-in the unit.



The configuration and management activities for the LonWorks networks are the responsibility of the client.



LonWorks technology uses the LonTalk® protocol for communicating between the network nodes. Contact the service supplier for further information.

MHP - High and low pressure gauges

Despite the unit already enabling a series of digital displays on the operating pressure of the refrigeration circuit, this option enables analogical measuring of refrigerant pressures at compressor intake and supply thus easing the checking of these parameters for the technicians who are managing the unit. The two liquid pressure gauges and related pressure sensors are attached built-in in easily accessible positions.

The device is built-in the unit.







Accessories separately supplied

RCTX - Remote control

This option allows to have full control over all the unit functions from a remote position.



It can be easily installed on the wall and has the same aspect and functions of the user interface on the unit.

-  All device functions can be repeated with a normal portable PC connected to the unit with an Ethernet cable and equipped with an internet navigation browser.
-  The device should be installed on the wall using suitable plugs, electrically hooked up and connected to the unit (installation and wiring are the responsibility of the Customer). Max. remote distance 350 m without auxiliary supply.
-  Data and power supply serial connection cable n.1 twisted and shielded pair. Diameter of the individual conductor 0.8 mm.
-  Installation provided by the Customer.



BACX - BACnet serial communication module

Allows the serial connection to supervision systems, by using BACnet as communication protocol. It allows the access to the entire list of operation variables, controls and alarms. With this accessory, every unit can communicate with the main supervision systems.

-  The configuration and management activities for the BACnet networks are the responsibility of the client.
-  The total length of each serial line do not exceed 1000 meters and the line must be connected in bus typology (in/out)
-  Installation provided by the Customer.



CMMBX - Serial communication module to supervisor (Modbus)

This enables the serial connection of the supervision system, using Modbus as the communication protocol. It enables access to the complete list of operational variables, commands and alarms. Using this accessory every unit can dialogue with the main supervision systems.

-  The total length of each serial line do not exceed 1000 meters and the line must be connected in bus typology (in/out)
-  Installation provided by the Customer.

CMSLWX - LonWorks serial communication module

This enables the serial connection of the supervision system which uses the LonWorks communication protocol. It enables access to a list of operating variables, commands and alarms which comply with the Echelon® standard.

-  The configuration and management activities for the LonWorks networks are the responsibility of the client.
-  LonWorks technology uses the LonTalk® protocol for communicating between the network nodes. Contact the service supplier for further information.
-  Installation provided by the Customer.

PGFCX - Finned coil protection grill

This accessory is used to protect the external coil from the accidental contact with external things or people.

Ideal for installation in places where persons can pass from, such as car parks, terraces, etc.

The accessory is supplied installed built-in the unit.

This option is not suitable for application in sulphuric environments

Installation provided by the Customer.

AVIBX - Anti-vibration mount support

The rubber antivibration mounts must be fixed to designated housings on the support stringers and are used to dampen vibrations produced by the unit, thereby reducing the noise transmitted to the support structures.

Installation provided by the Customer.

IFWX - Steel mesh strainer on the water side

The device stops the exchanger from being clogged by any impurities which are in the hydraulic circuit. The mechanical steel mesh strainer must be placed on the water input line. It can be easily dismantled for periodical maintenance and cleaning. It also includes:

- cast-iron shut-off butterfly valve with quick connections and activation lever with a mechanical calibration lock;
- quick connections with insulated casing.

Installation provided by the Customer.

Steel mesh strainer pressure drops

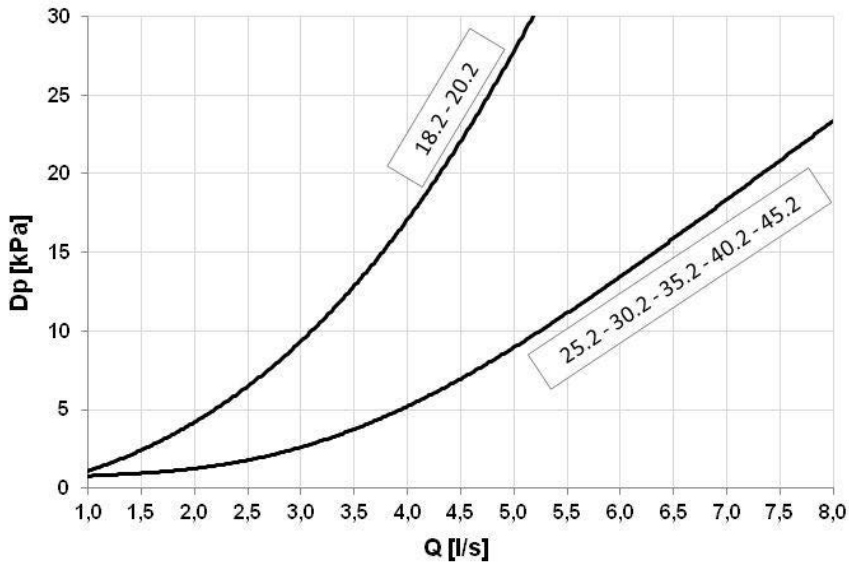

Q = Water flow rate[l/s]
 DP = Water side pressure drops [kPa]



Dimensional drawings

Size 18.2 -20.2

DAAM418 2_20 2_0 REV00
22/10/2015

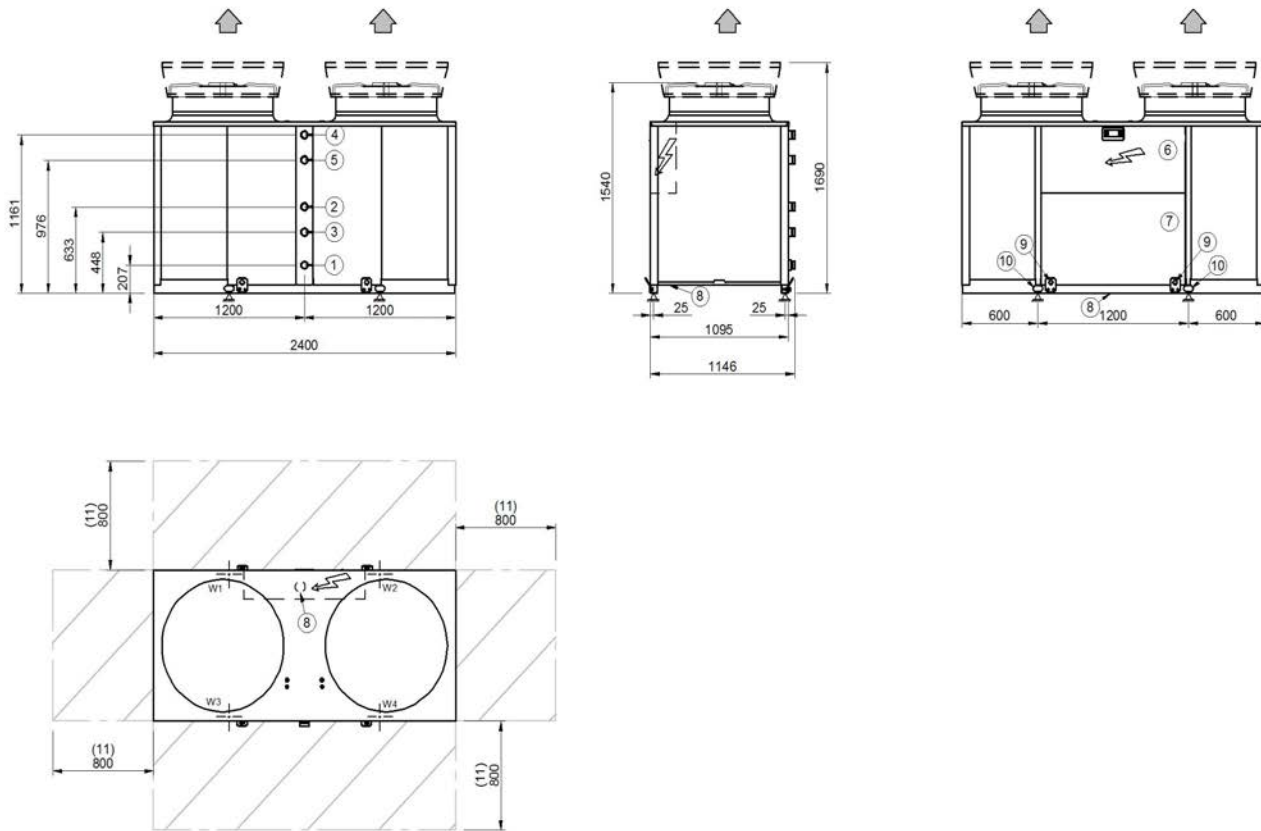

- | | |
|--|---------------------------------|
| 1. Return for the user side Ø 2" Victaulic | 7. Compressor compartment |
| 2. Supply to the user side Ø 2" Victaulic | 8. Power input |
| 3. Return for the recovery side Ø 2" Victaulic | 9. Lifting brackets (removable) |
| 4. Supply to the recovery side Ø 2" 1/2 Victaulic | 10. Unit fixing holes |
| 5. Recovery side water outlet for DHW preparation Victaulic Ø 2" | 11. Functional spaces |
| 6. Electrical panel | |

Size		18.2	20.2
A - Length	mm	2400	2400
B - Width	mm	1100	1100
C - Standard unit height	mm	1540	1540
C - Height with HEDIF option	mm	1690	1690
W1 supporting point	kg	174	178
W2 Supporting point	kg	172	177
W3 Supporting point	kg	152	153
W4 Supporting point	kg	152	152
Shipping weight	kg	630	640
Operating weight	kg	650	660

The presence of optional accessories may result in a substantial variation of the weights shown in the table.

Dimensional drawings

Size 25.2 -30.2

DAAM425 2_30 2_0 REV00
22/10/2015

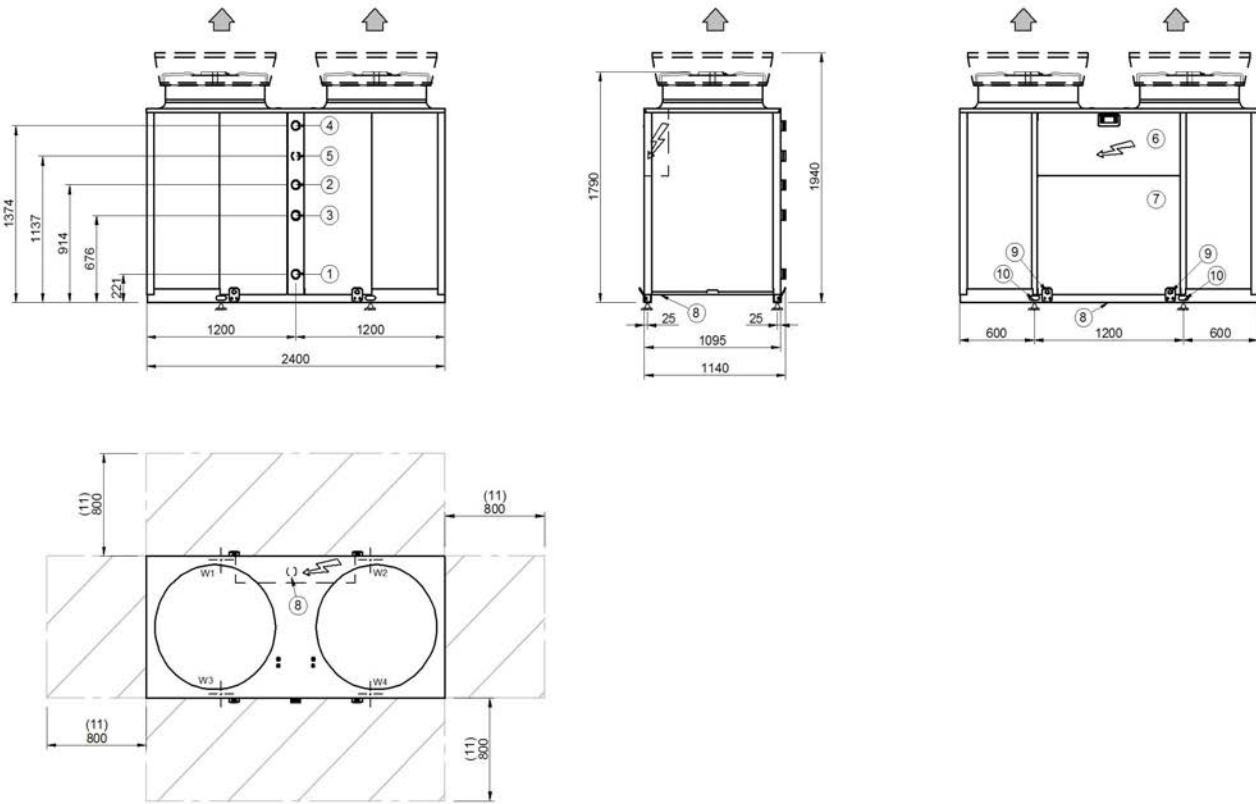

- | | |
|---|---------------------------------|
| 1. Return for the user side Ø 2"1/2 Victaulic | 7. Compressor compartment |
| 2. Supply to the user side Ø 2"1/2 Victaulic | 8. Power input |
| 3. Return for the recovery side Ø 2"1/2 Victaulic | 9. Lifting brackets (removable) |
| 4. Supply to the recovery side Ø 2"1/2 Victaulic | 10. Unit fixing holes |
| 5. Recovery side water outlet for DHW preparation Victaulic Ø 2"1/2 " | 11. Functional spaces |
| 6. Electrical panel | |

Size		18.2	20.2
A - Length	mm	2400	2400
B - Width	mm	1100	1100
C - Standard unit height	mm	1790	1790
C - Height with HEDIF option	mm	1940	1940
W1 supporting point	kg	198	212
W2 Supporting point	kg	202	212
W3 Supporting point	kg	159	165
W4 Supporting point	kg	161	165
Shipping weight	kg	700	725
Operating weight	kg	720	755

The presence of optional accessories may result in a substantial variation of the weights shown in the table.

Dimensional drawings

Size 35.2 - 40.2 - 45.2

DABM435.2_40 2_45.2_0 REV00
14/09/2015

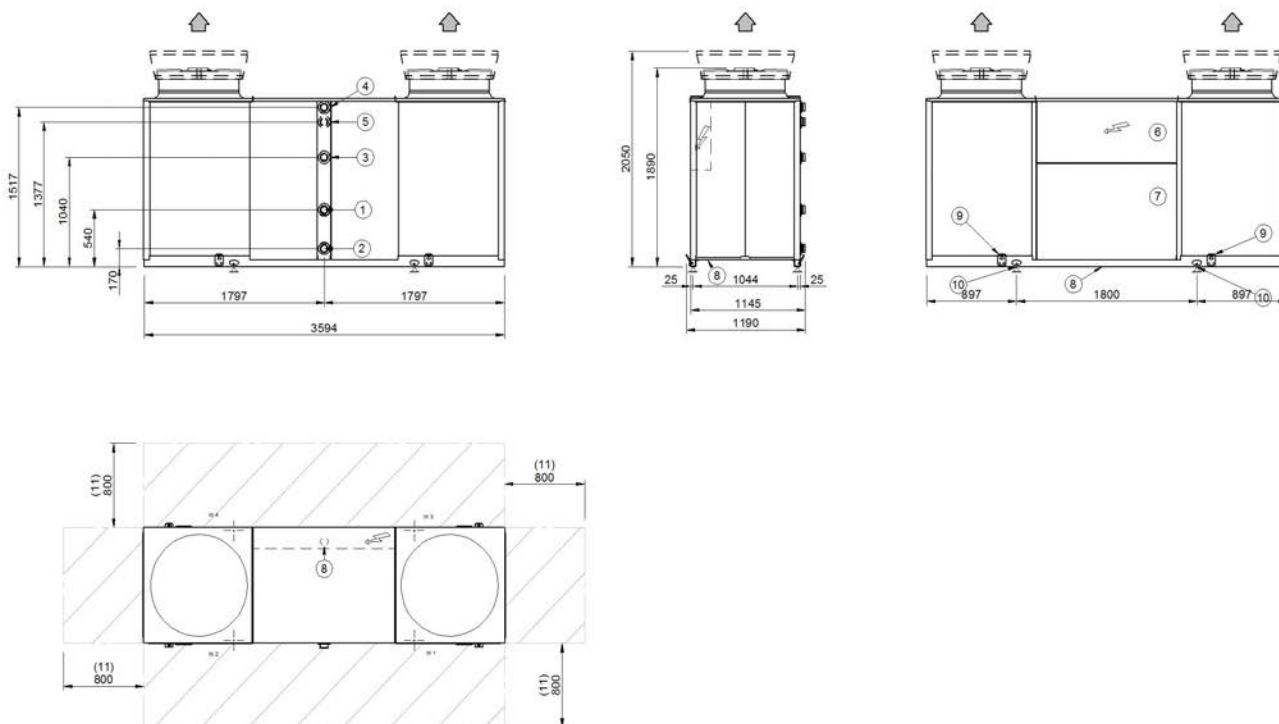

- | | |
|--|---------------------------------|
| 1. Return for the user side Ø 2" 1/2 Victaulic | 7. Compressor compartment |
| 2. Supply to the user side Ø 2" 1/2 Victaulic | 8. Power input |
| 3. Return for the recovery side Ø 2" 1/2 Victaulic | 9. Lifting brackets (removable) |
| 4. Supply to the recovery side Ø 2" 1/2 Victaulic | 10. Unit fixing holes |
| 5. Recovery side water outlet for DHW preparation Ø 2" 1/2 Victaulic | 11. Functional spaces |
| 6. Electrical panel | |

Size		35.2	40.2	45.2
A - Length	mm	3600	3600	3600
B - Width	mm	1100	1100	1100
C - Standard unit height	mm	1890	1890	1890
C - Height with HEDIF option	mm	2050	2050	2050
W1 supporting point	kg	218	229	253
W2 Supporting point	kg	218	226	255
W3 Supporting point	kg	249	263	291
W4 Supporting point	kg	249	259	294
Shipping weight	kg	908	950	1060
Operating weight	kg	934	977	1093

The presence of optional accessories may result in a substantial variation of the weights shown in the table.

Page intentionally left blank

Page intentionally left blank

**CLIVET SPA**

Via Camp Lonc 25, Z.I. Villapaiera - 32032 Feltre (BL) - Italy
Tel. + 39 0439 3131 - Fax + 39 0439 313300 - info@clivet.it

CLIVET GROUP UK Limited

4 Kingdom Close, Segensworth East - Fareham, Hampshire - PO15 5TJ - United Kingdom
Tel. + 44 (0) 1489 572238 - Fax + 44 (0) 1489 573033 - enquiries@clivetgroup.co.uk

CLIVET GROUP UK Limited (Operations)

Units F5&F6 Railway Triangle Ind Est, Walton Road - Portsmouth, Hampshire - PO6 1TG - United Kingdom
Tel. +44 (0) 2392 381235 - Fax. +44 (0) 2392 381243 - service@clivetgroup.co.uk

CLIVET ESPAÑA S.A.U.

C/ Bac de Roda, 36 - 08019 Barcelona - España
Tel: +34 93 8606248 - Fax +34 93 8855392 - info@clivet.es

Av.Manoterás Nº 38, Oficina C303 - 28050 Madrid - España
Tel. +34 91 6658280 - Fax +34 91 6657806 - info@clivet.es

CLIVET GmbH

Hummelsbütteler Steindamm 84, 22851 Norderstedt - Germany
Tel. + 49 (0) 40 32 59 57-0 - Fax + 49 (0) 40 32 59 57-194 - info.de@clivet.com

CLIVET RUSSIA

Elektrozavodskaya st. 24, office 509 - 107023, Moscow, Russia
Tel. + 74956462009 - Fax + 74956462009 - info.ru@clivet.com

CLIVET MIDEAST FZCO

Dubai Silicon Oasis (DSO), High Bay Complex, Office N. 20, PO BOX 342009, Dubai, UAE
Tel. + 9714 3208499 - Fax + 9714 3208216 - info@clivet.ae

CLIVET AIRCONDITIONING SYSTEMS PRIVATE LIMITED

501/502, Commercial-1, Kohinoor City, Old Premier Compound, Kirol Road, Off L B S Marg, Kurla West - Mumbai 400 070 - India
info.in@clivet.com

www.clivet.com
www.clivetlive.com

A Group Company of

